

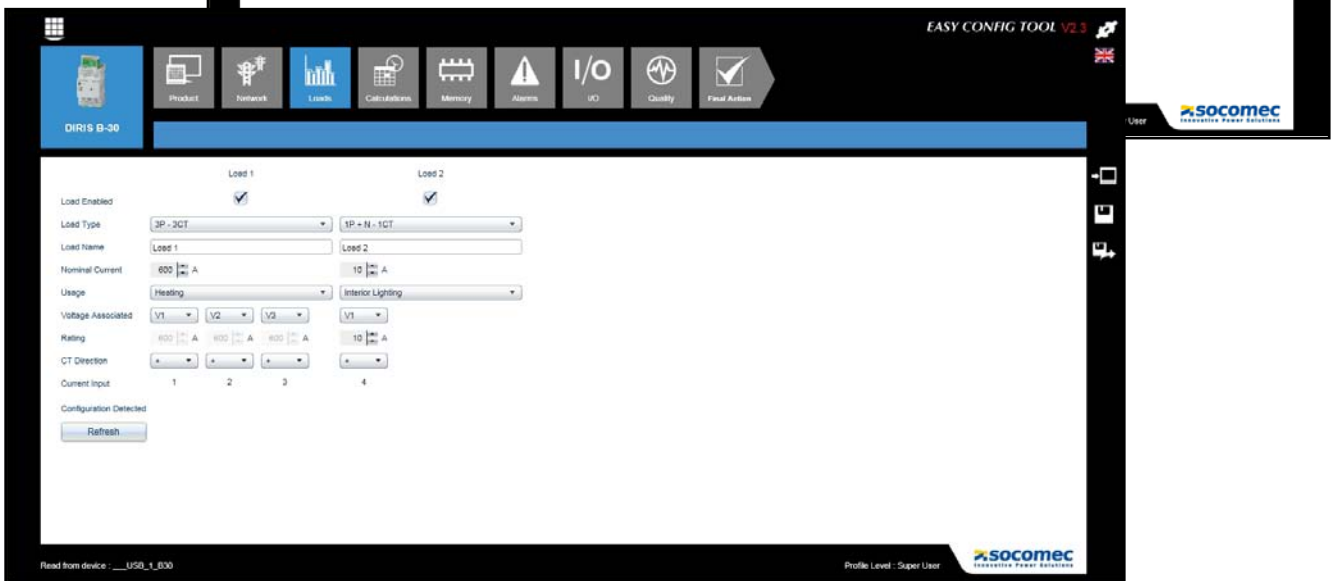

Easy Config

Configuration tool
for ATYS, COUNTIS and DIRIS

EN



www.socomec.com/easy-config_software

- 1. DOCUMENTATION** 3
- 2. PRELIMINARY OPERATIONS** 3
- 3. INTRODUCTION** 3
- 4. INSTALLATION** 3
- 5. STARTING** 4
 - 5.1. New file 5
 - 5.2. Open file 5
 - 5.3. Get from Device 5
 - 5.3.1. Ethernet connection 6
 - 5.3.2. RS485 Modbus connection 8
 - 5.3.3. USB connection 8
 - 5.4. List of devices 11
- 6. PRESENTATION OF THE CONFIGURATION INTERFACE** 12
 - 6.1. Selecting the user profile 12
 - 6.2. Electricity Network Configuration 13
 - 6.3. Configuring Loads 14
 - 6.4. Calculations Configuration 15
 - 6.5. Memory Configuration 16
 - 6.6. Alarms Configuration 17
 - 6.6.1. Measurement Alarm 17
 - 6.6.2. Logic Alarm 18
 - 6.6.3. Combination Alarm 18
 - 6.6.4. Load Shedding Alarm 19
 - 6.7. I/O configuration 19
 - 6.8. Quality Configuration 20
 - 6.9. COM Module Configuration 20
 - 6.10. Final action 20
- 7. CONFIGURATION OF THE DIRIS G GATEWAY** 22
 - 7.1. IP address 22
 - 7.2. Date / Time 22
 - 7.3. E-mail 23
 - 7.4. Multi-tariff 24
 - 7.5. Radio-frequency (RF) 25
 - 7.6. Device detection 26
 - 7.6.1. Automatic auto-addressing 26
 - 7.6.2. Semi-automatic auto-addressing 27
 - 7.7. Final action 30
- 8. CONFIGURATION OF THE TRANSFER SWITCH** 31
 - 8.1. Status and control screen 31
 - 8.2. Setting screen 1 31
 - 8.3. Setting screen 2 32
 - 8.4. Power management screen (only available for ATyS p) 33
 - 8.5. Engine exerciser screen (only available for ATyS p) 33
 - 8.6. Inputs screen 34
 - 8.7. Outputs screen 34
 - 8.8. Timers screen 1 34
 - 8.9. Timers screen 2 35
 - 8.10. Timers screen 3 36
 - 8.11. Event recording screen (only available for ATyS p) 36
 - 8.12. Super User added functionality 37
 - 8.12.1. Status and control screen 37
 - 8.12.2. Reste screen (only available for ATyS p) 38
 - 8.13. Final action 39

1. DOCUMENTATION

All documentation on the Easy Config is available on the SOCOMEC website at the following address:
http://www.socomec.com/easy-config_software



2. PRELIMINARY OPERATIONS

It is advisable to become thoroughly acquainted with the contents of this manual before using the Easy Config.

3. INTRODUCTION

Easy Config is a software tool for configuring the DIRIS Digiware, DIRIS B-30, DIRIS BCMS, DIRIS A ranges of measurement systems, COUNTIS energy meters, DIRIS G communication gateways and ATYS motorised supply inverters equipped with a RS85 Modbus communication port, Ethernet Modbus TCP or USB. Once completed, the configuration can be applied directly to the devices through the communication port. The configuration can also be saved as a file on the User's PC.

4. INSTALLATION

Setting up must be performed by the Administrator of the destination PC.

Run set-up with the aid of the file setup.exe which you can find in the Easy Config directory. Right-click on the application then "Run as administrator" and follow the set-up steps.

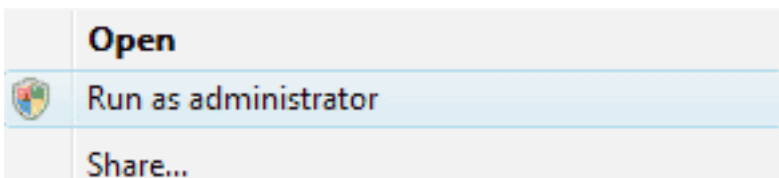

5. STARTING

Go to the menu Starting "All programs/Socomec/Easy Config" and start the Easy Config program.

The following screen is displayed:

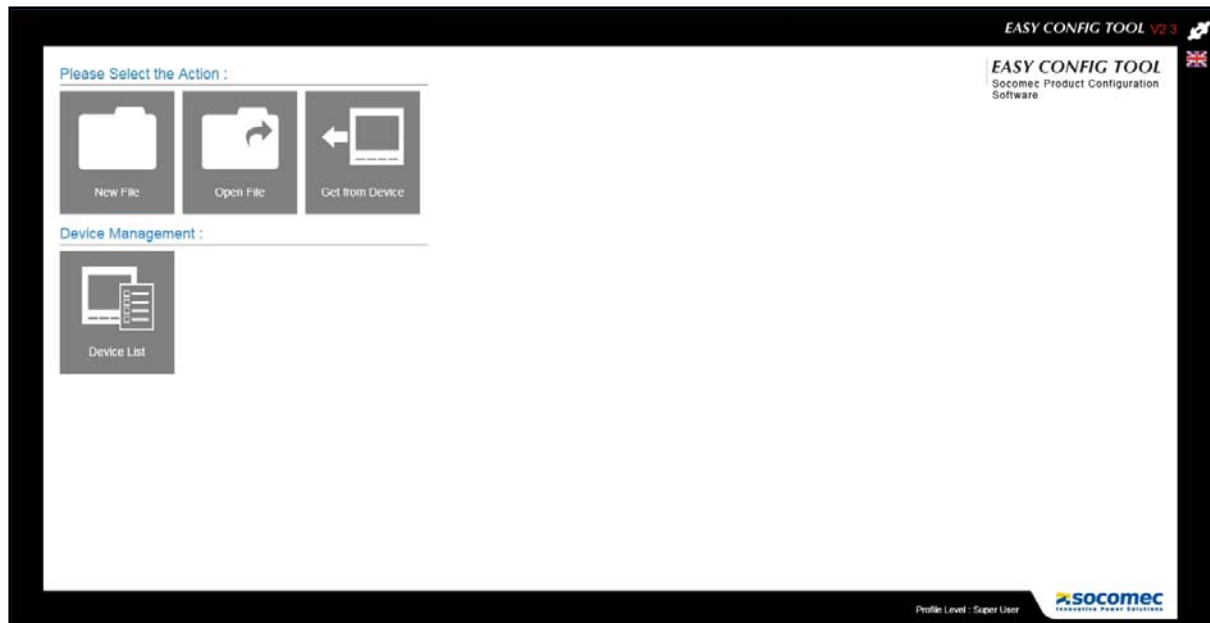

Configuration can be carried out from a file or directly from a device:

- [New File](#) -> Creation of a new configuration file
- [Open File](#) -> Open an existing configuration file on the PC and edit it
- [Get from Device](#) -> Read the configuration of a connected device to edit it

In order to facilitate set-up configuration, the devices can be classified in groups (for example: according to their type or location). This function is interesting for managing a large number of devices.

- [Device List](#) -> Shows the library of devices with their coordinates. The devices can be classified and grouped according to this list.

5.1. New file

This function allows you to create a configuration file for a given device, it is not necessary to connect the device concerned. The configuration will be based on the device's factory default settings.

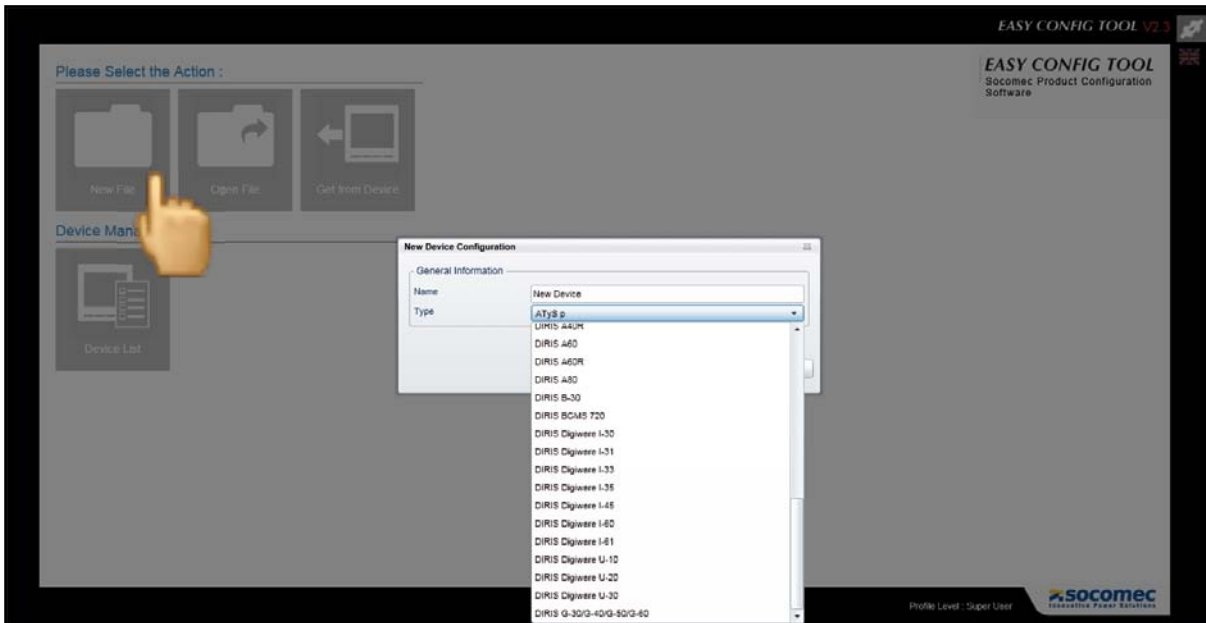

The [Type](#) of device to be configured (DIRIS, COUNTIS, ATYS...) is selected from the list. A [Name](#) can be given to each configuration.

By clicking on [OK](#) once the device has been selected and the name chosen, the user can access the configuration screens.

5.2. Open file

This action allows you to open a configuration file previously saved on the PC. After editing, the file can be saved again and/or applied directly to the connected device.

5.3. Get from Device

The user is offered several possibilities for connecting to the device.

5.3.1. Ethernet connection

The device is connected in RS485 by means of an Ethernet gateway or a display.

Configuration examples

- DIRIS B-30 RS485 by means of an Ethernet gateway DIRIS G

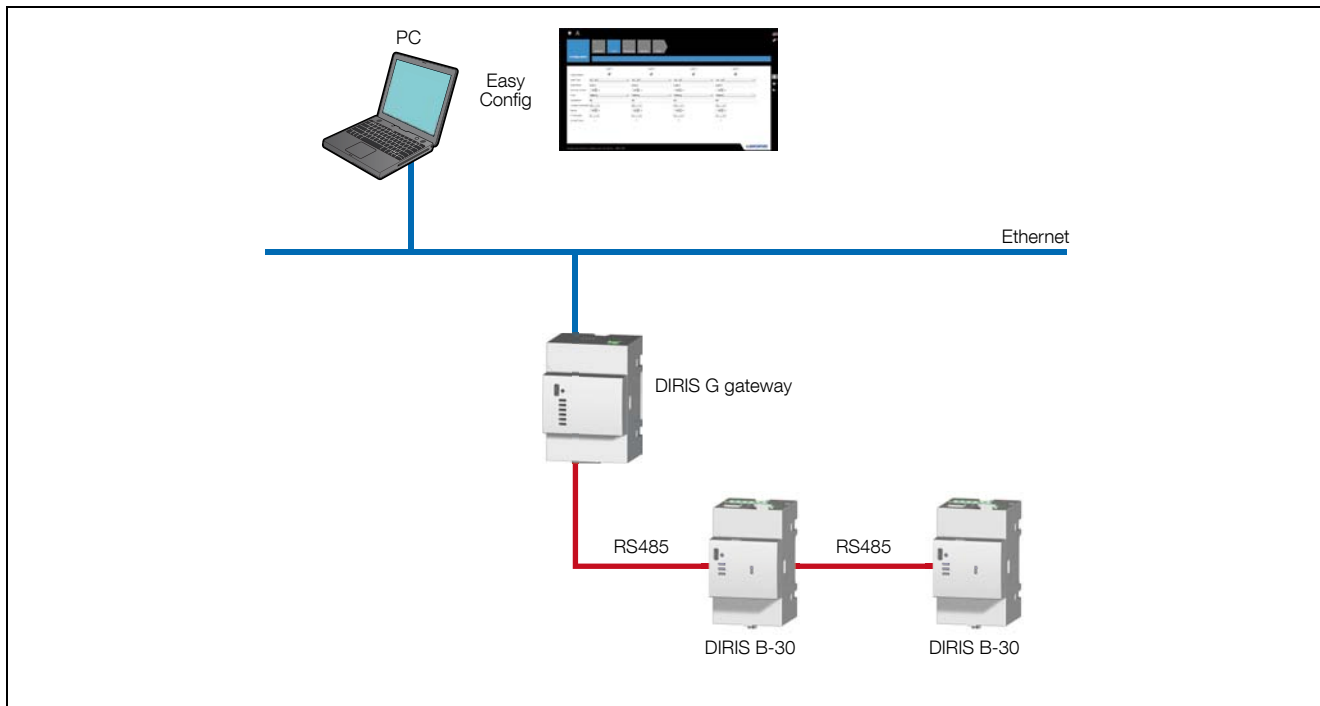

- DIRIS B-30 and DIRIS Digiware by means of the DIRIS Digiware D-50 display

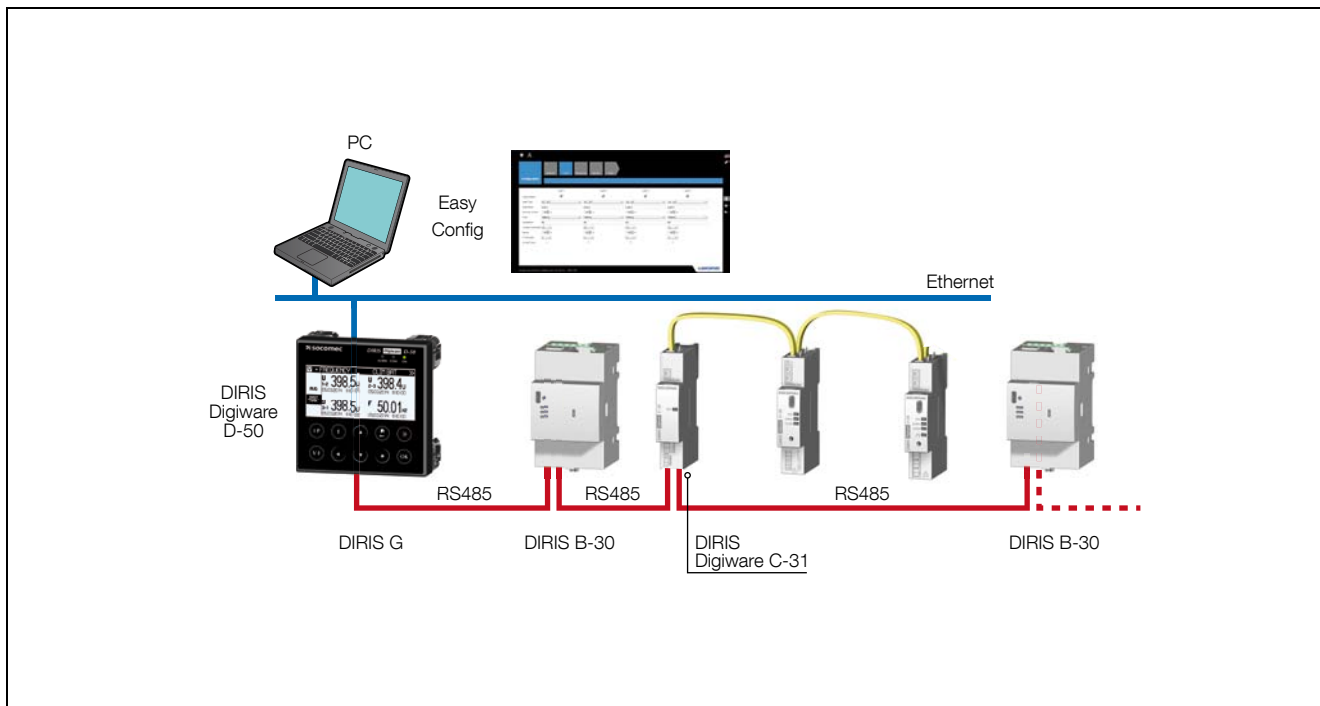

Click [Get from Device](#) then [Add a Device](#) (top right) to see the general information and the Modbus address. Even if the device is connected by means of a DIRIS G gateway or a DIRIS Digiware D-50 display, the IP address will still be necessary.

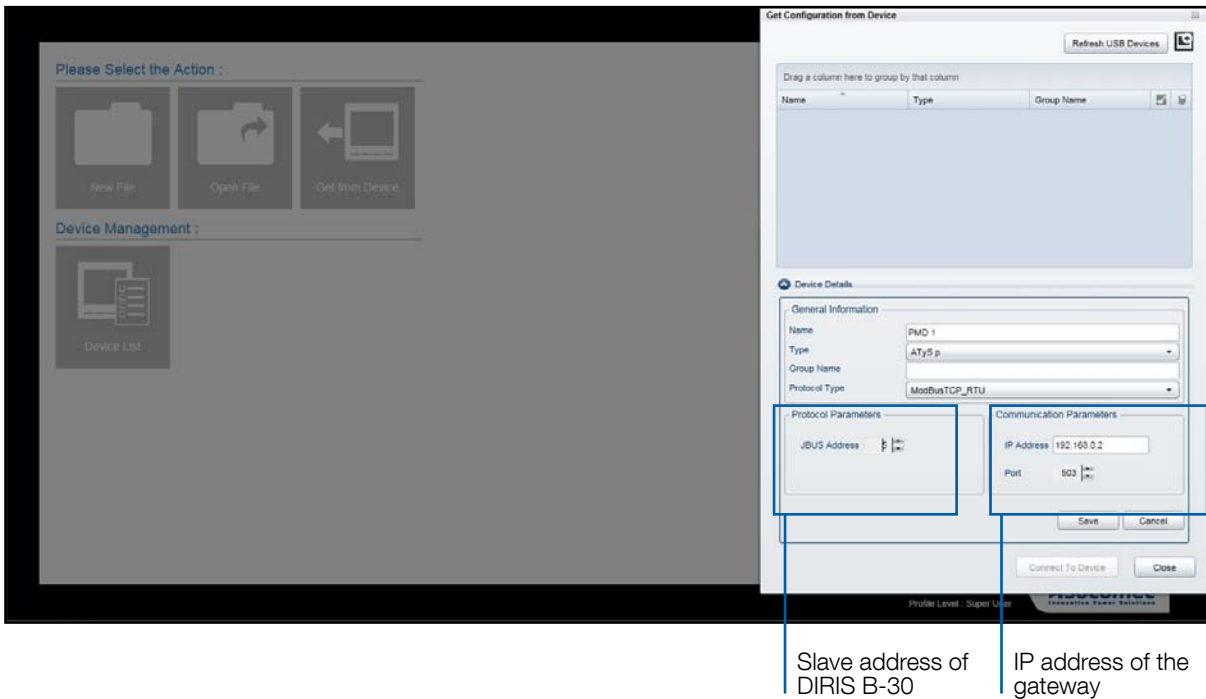

In the case of an Ethernet connection by means of a gateway or a display, the list of all the slave devices is automatically recovered if addressing of the products has been carried out, see “7.6. Device detection”, page 26.

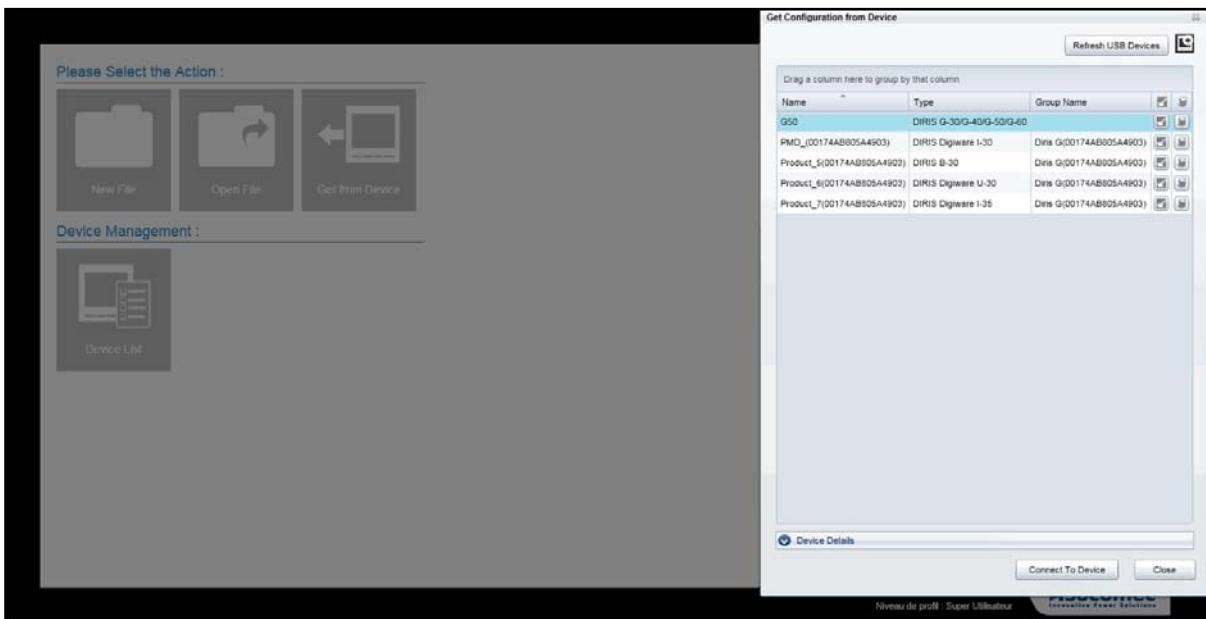

Choose the device to be configured and click [Connect To Device](#).

5.3.2. RS485 Modbus connection

The device is directly connected via RS485.

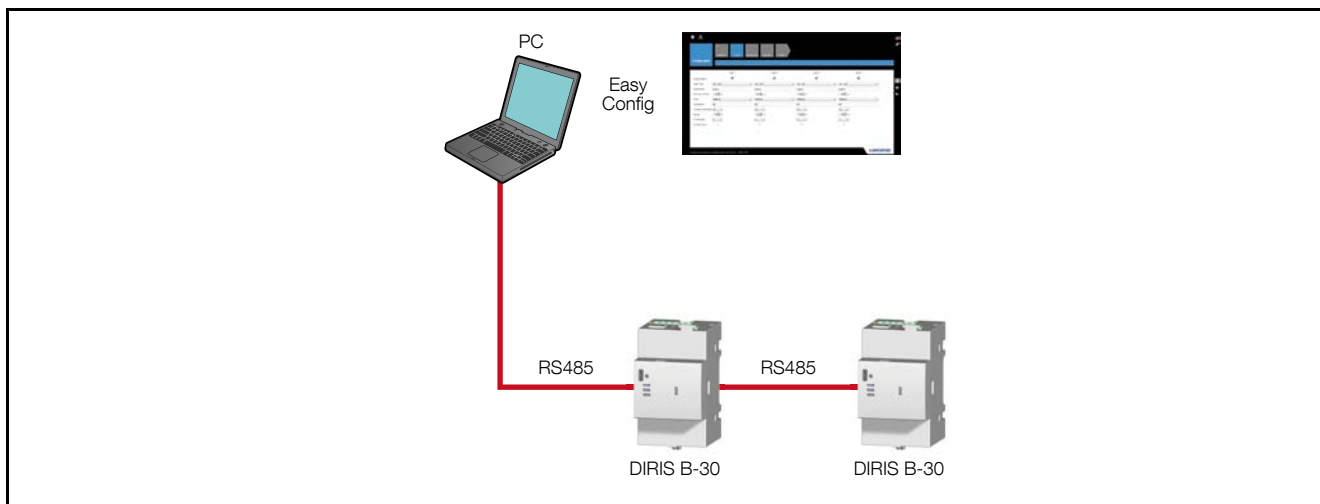

Click on the icon [Get from Device](#) to find general information and the Modbus address.

5.3.3. USB connection

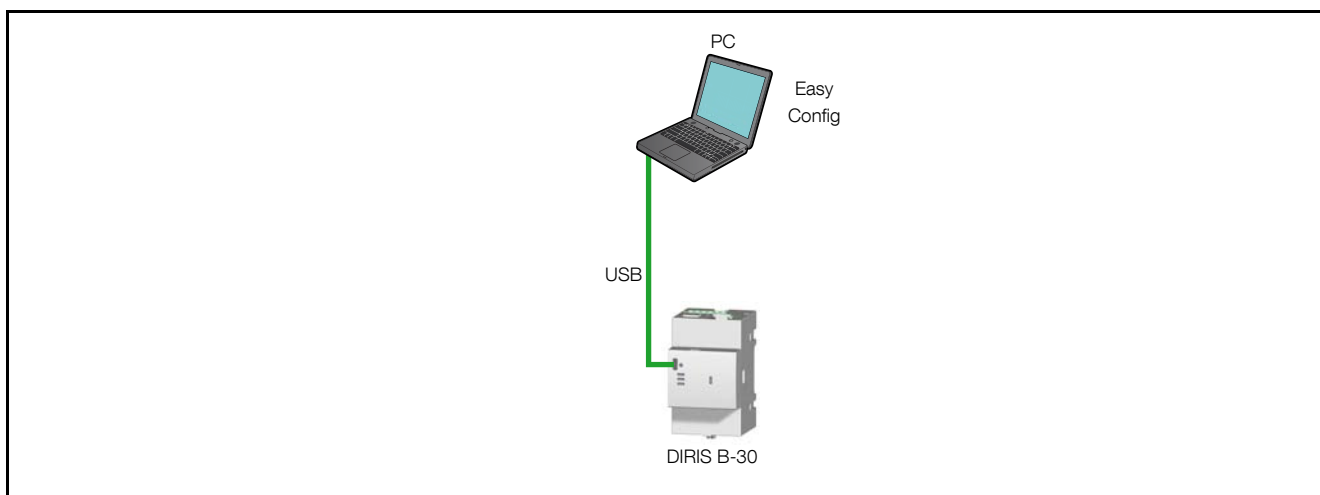

Click [Get from Device](#) then [Refresh USB Devices](#) to access the device connected via USB.

In this case there is no parameter to be given, detection will take place automatically.

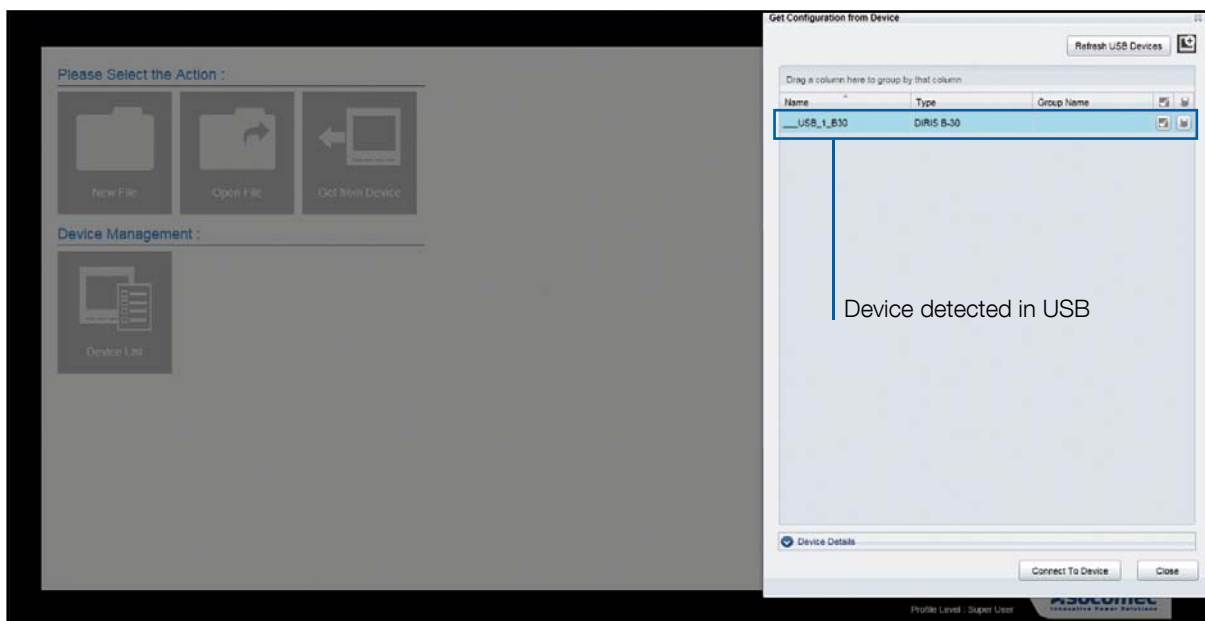

In the case of a USB connection by means of a DIRIS G gateway:

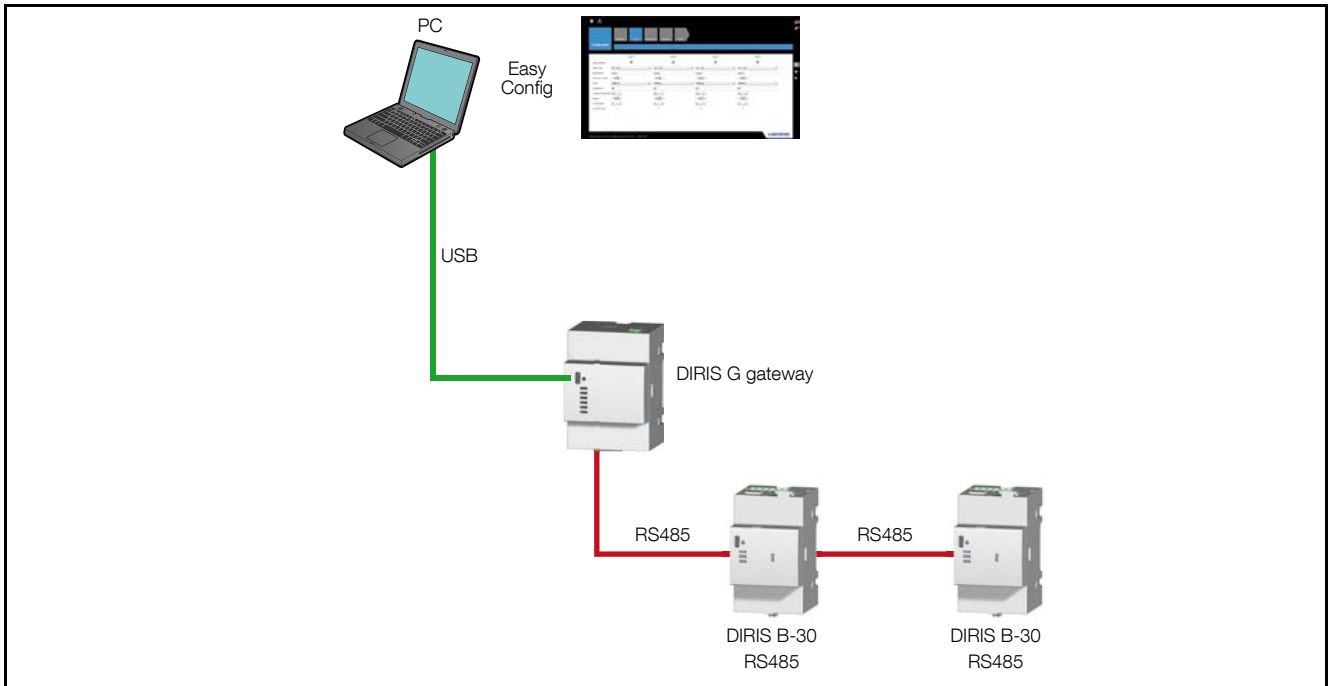

In the case of a USB connection by means of a DIRIS D-40/D-50 display:

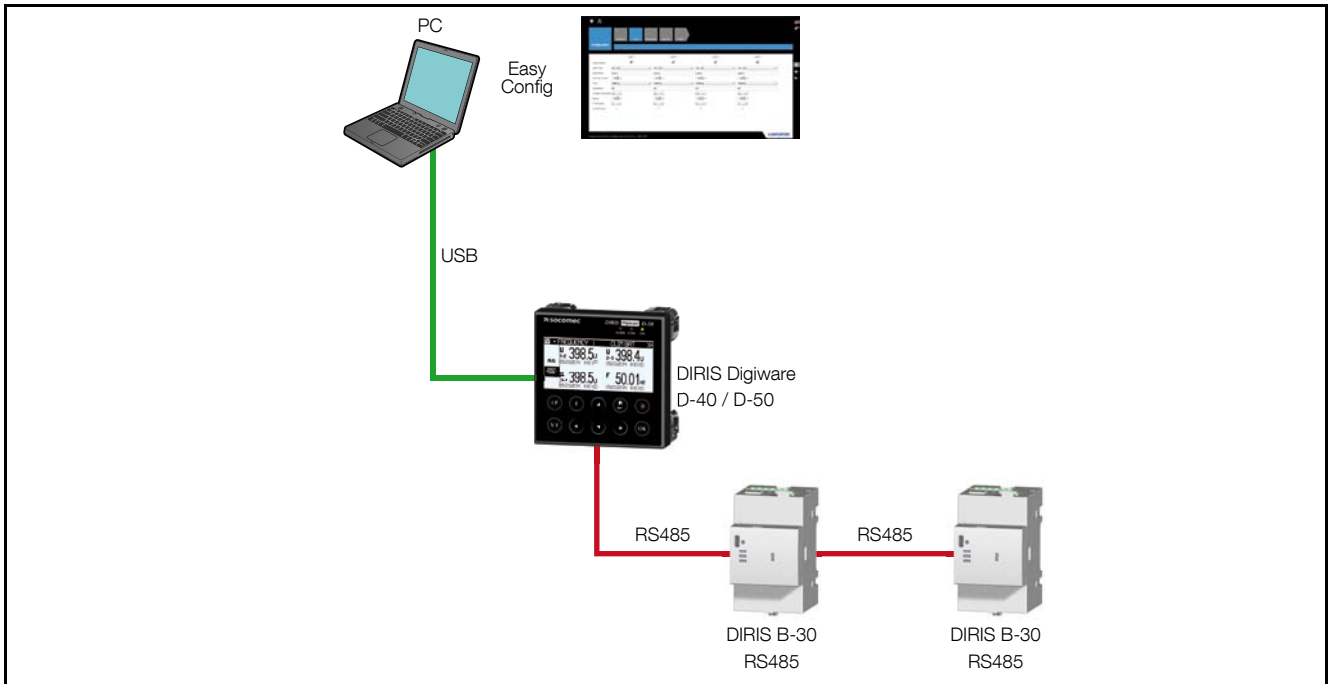

In the case of a USB connection by means of a gateway or a display, the list of all the slave devices is automatically recovered if the devices have been allocated addresses, see “7.6. Device detection”, page 26.

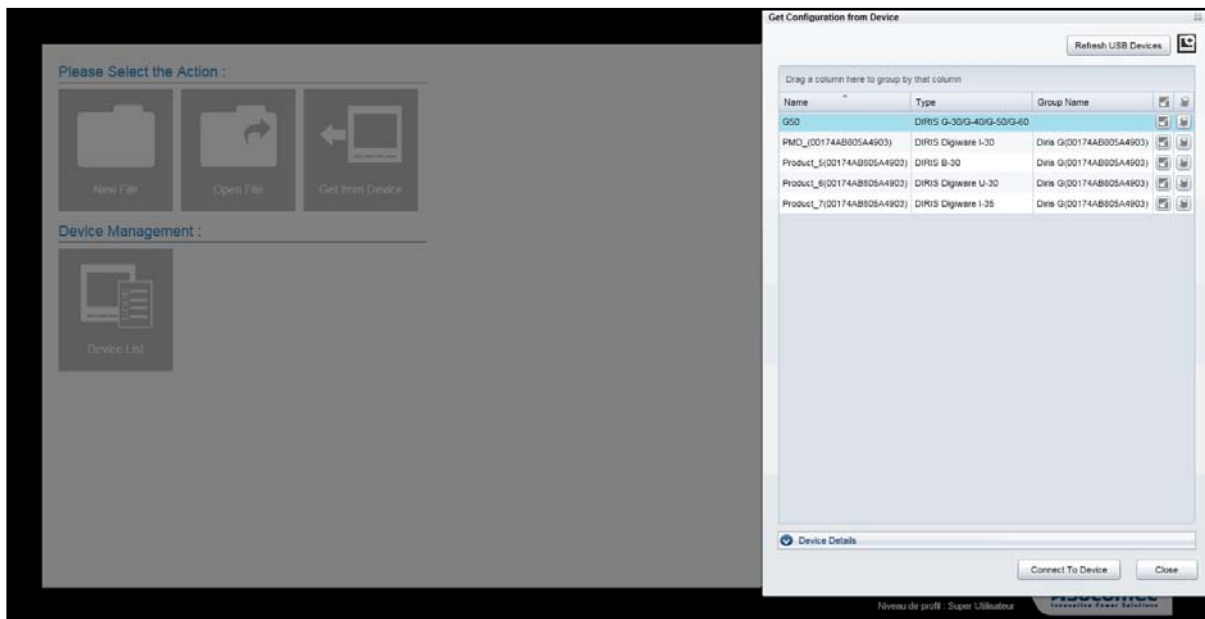

Choose the device to be configured and click [Connect To Device](#).

Access to product configuration is obtained by simply giving its address without connecting the USB cable to the product concerned.

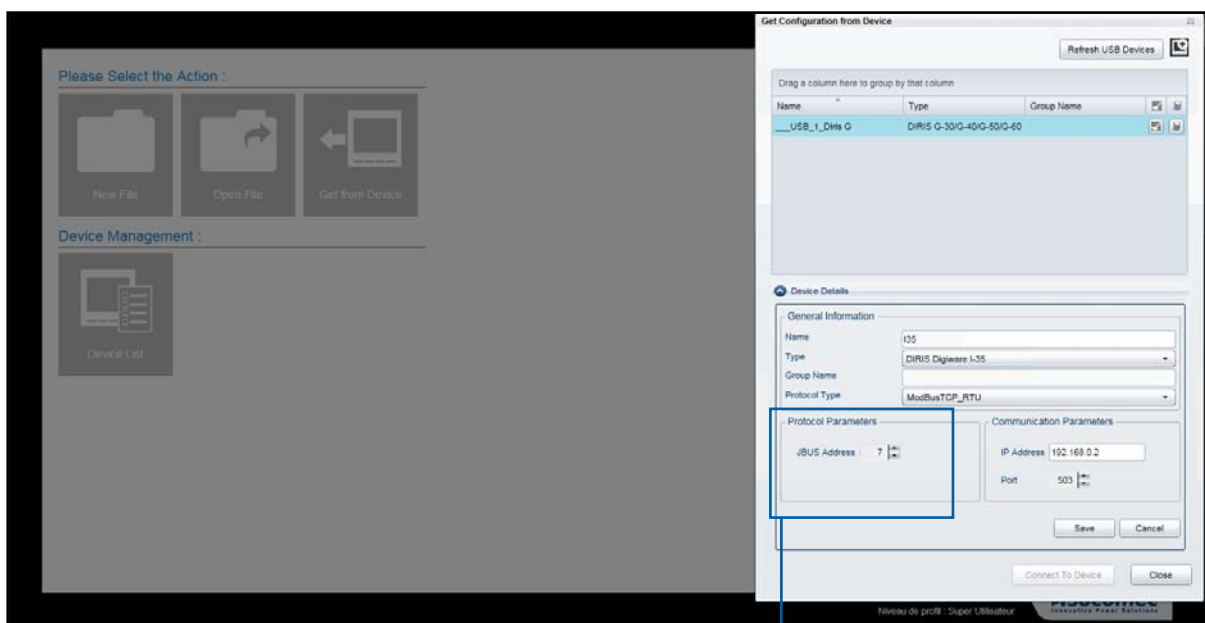

Address of
DIRIS Digiware
I-35

Choose the device to be configured and click on [Connect To Device](#)

5.4. List of devices

In the case of an Ethernet or USB connection by means of a DIRIS G gateway or DIRIS D display, the connected devices can be grouped and classified according to the group chosen.

For example, it is possible to classify the products by field: [Group Name](#), [Type](#) or [Name](#)

The [Group Name](#) may be for example the geographical location of the products which the user will enter in the Group Name field.

Grouping is carried out by dragging and dropping the field [Group Name](#), [Type](#) or [Name](#) onto the line [Drag a column here to group by that column](#).

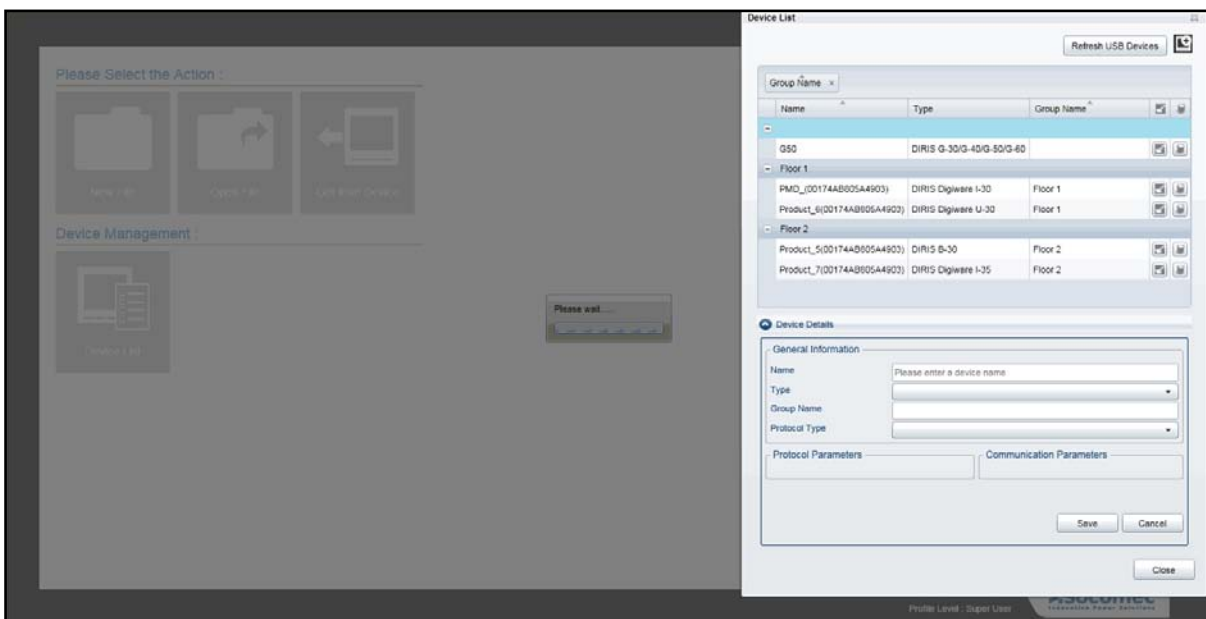
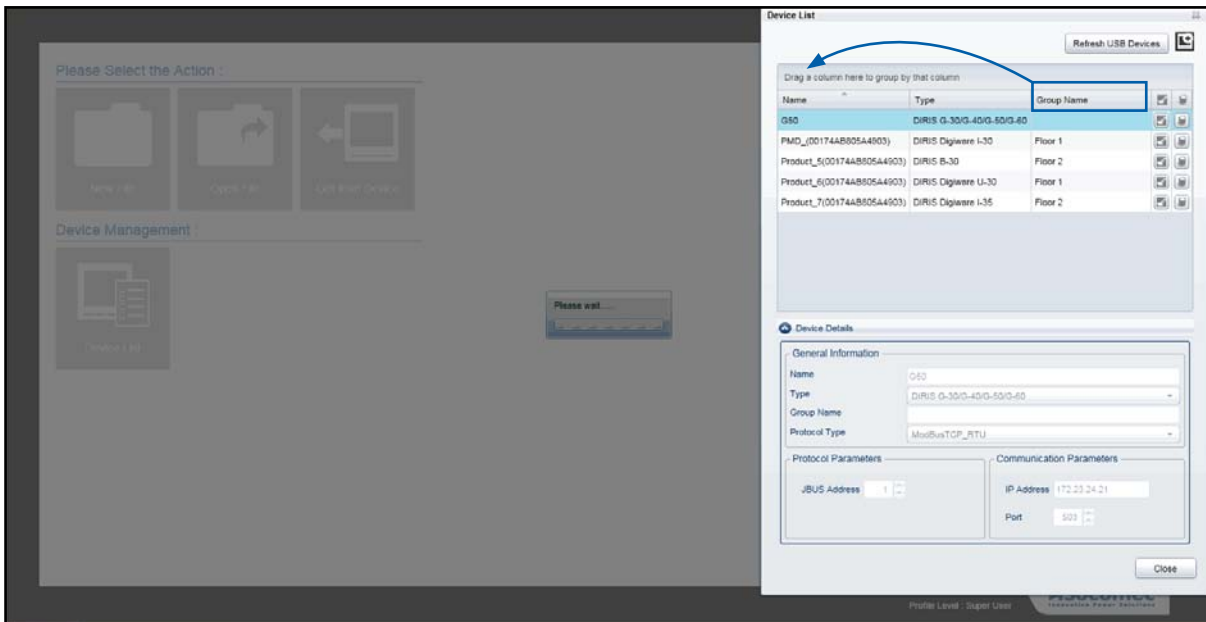

6. PRESENTATION OF THE CONFIGURATION INTERFACE

Once the device has been selected, the configuration screens appear in the form of "tiles". Each tile corresponds to a function to be configured. The "tile" selected is blue, the others are grey.

The example shown on the following pages refers to the DIRIS B-30, the interface for another device will be similar with the tiles dynamically adapted to its functions.

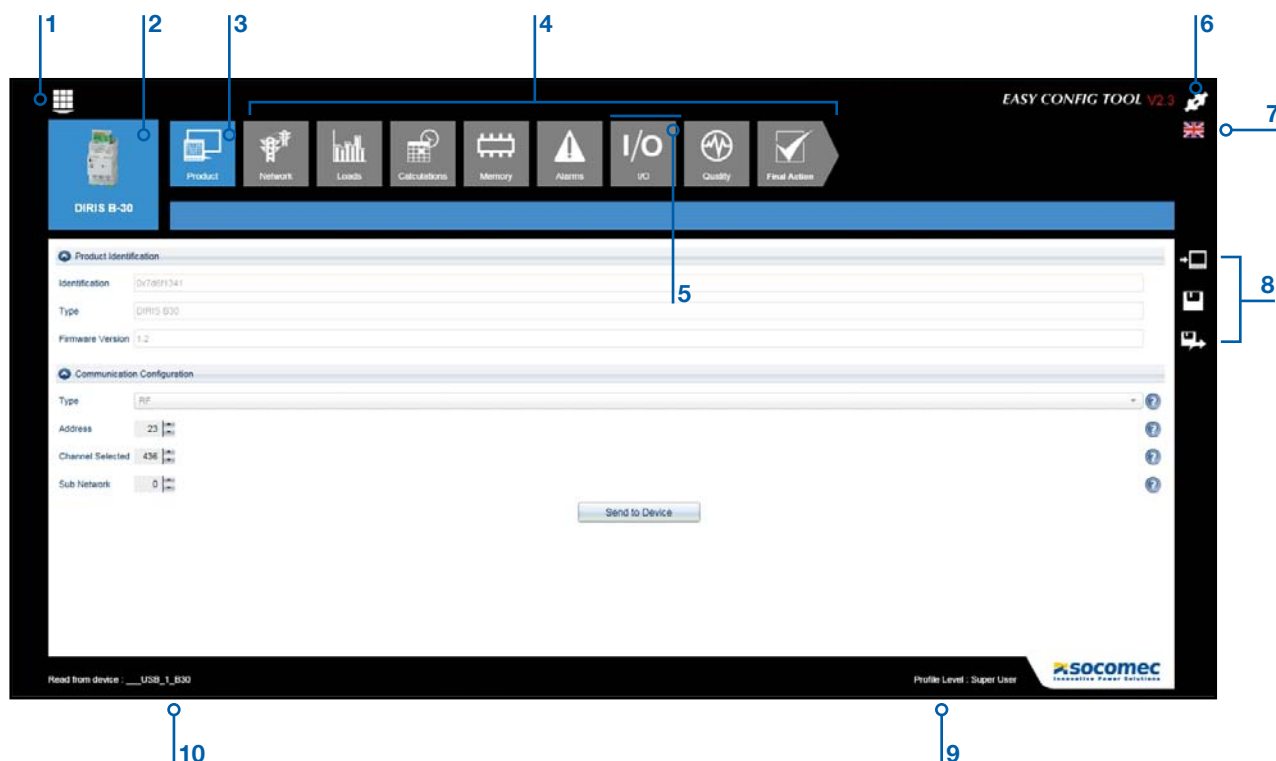

1. Access to the general menu
 2. Device to be configured
 3. Function* selected (blue tile)
 4. Functions* not selected (grey tiles)
 5. The blue line over the tile indicates that the default configuration has been modified.
 6. Selecting the user profile
 7. Selecting the language
 8. Short-cut to storage actions
 9. Current user profile
 10. Current selected device
- NB: * The functions available depend on the product to be configured.

6.1. Selecting the user profile

Three types of profiles are available: [User](#), [Administrator](#), [Super User](#), with more or less important rights.

	Creating a configuration and saving it on the PC	Displaying the configuration of a device	Sending a configuration to a device	Sending a command to a device	Password management	Default password
User	•	•				no password
Administrator	•	•	•	•		SocoAdm
Super User	•	•	•	•	•	sOcOmec

NB: Take care to respect upper and lower case letters in the passwords.

6.2. Electricity Network Configuration

This function concerns the electricity network parameters. It allows you to choose the type of network, the rated voltage, the frequency and the characteristics of a possible voltage transformer.

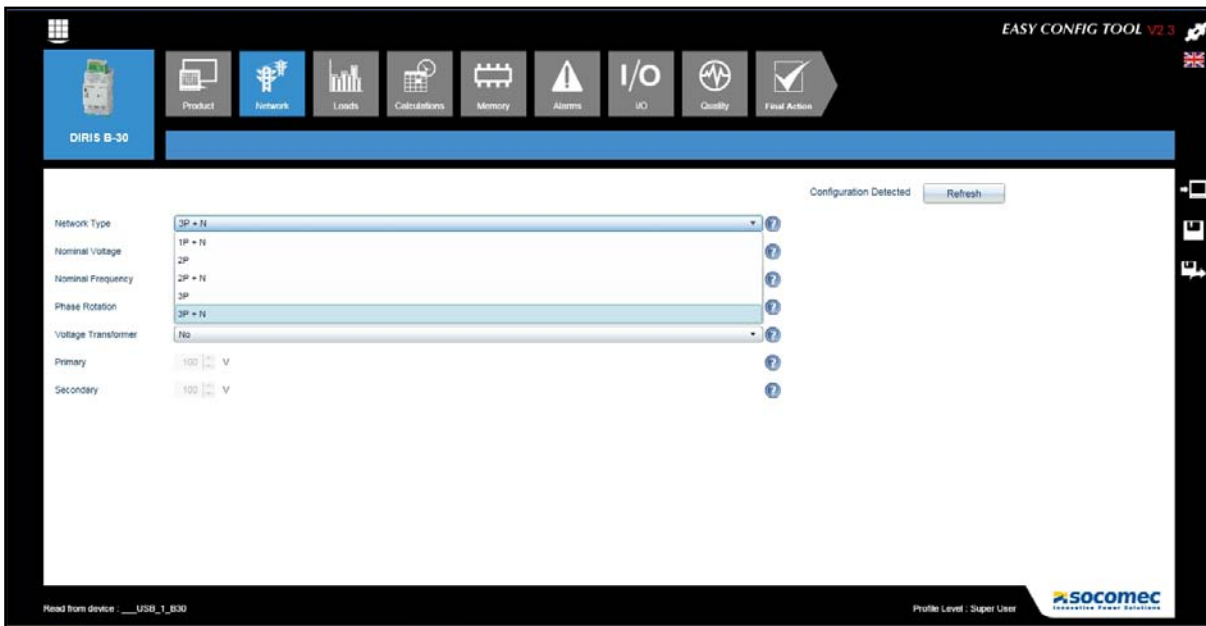

NB: In the case of a DIRIS Digiware system, the voltage module U must be configured first.

Incorrect configuration:

For the fields where the user has to write a value, if the latter is incompatible with the device, the corresponding field will be displayed in red with an error message. This operating principle applies to all Easy Config screens.

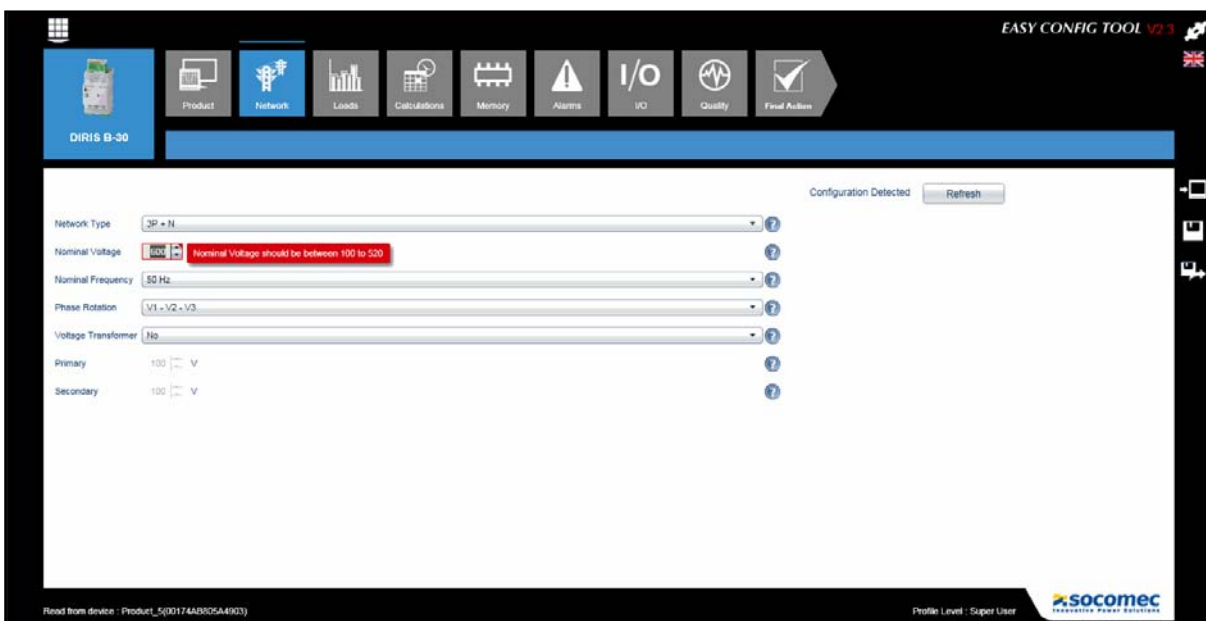

6.3. Configuring Loads

This function is specific for DIRIS Digiware and DIRIS B-30. Configuration can be carried out from a file or directly from a device. The selection of the sensors (CT) will depend on the mode chosen.

- [New File / Open File](#) -> The rating of the current sensor is chosen freely. The coherence with the sensor connected to the device will be checked when sending the configuration to the device.
- [Get from Device](#) -> The rating of the current sensor connected to the device is detected automatically.

Depending on the network chosen and the type of current sensors, it is possible to choose the number and type of loads to be measured. For example, three-phase loads, single-phase loads, or a combination of single-phase and three-phase loads.

In order to describe the configuration of loads, an example of a configuration is chosen below with a three-phase load associated with the voltages V1-V2-V3 and a single-phase load associated with the voltage V1.

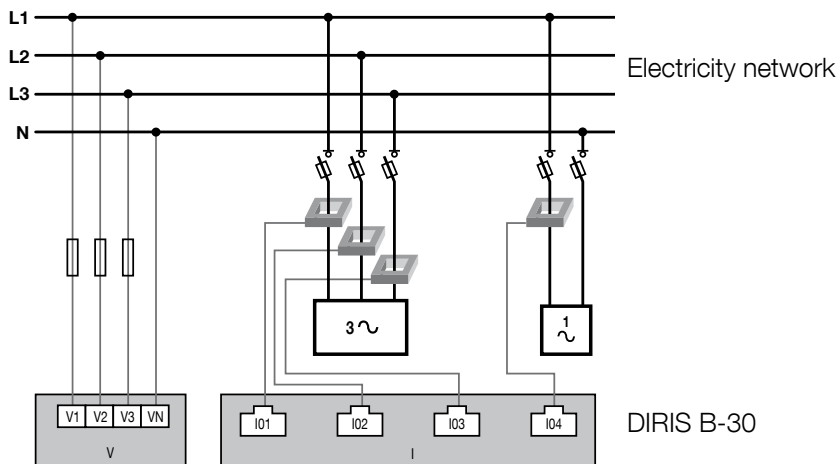

Note: The rated current may be different from the rating of the current sensor (CT). For example, it is possible to have a 630A sensor measuring the current of a 500A rated load. This choice will have no effect on the measurement accuracy, but will allow you to define the scale of the bar graphs used in the WEBVIEW Web server.

Configuration Detected

In [Get from Device](#) mode, if the device is connected to its loads by means of the sensors, when the [Refresh](#) key is pressed, a configuration will be proposed to the user depending on the loads detected. This function requires a minimum 2% load current.

This proposition will indicate the type of load, the associated voltages and the direction of the current. If this proposal is suitable, it will be entered manually in the corresponding configuration fields. The configuration detected also allows the user to check the compliance of the wiring.



6.4. Calculations Configuration

This function allows you to choose the integration periods of calculations for instantaneous values, mean values and load curves.

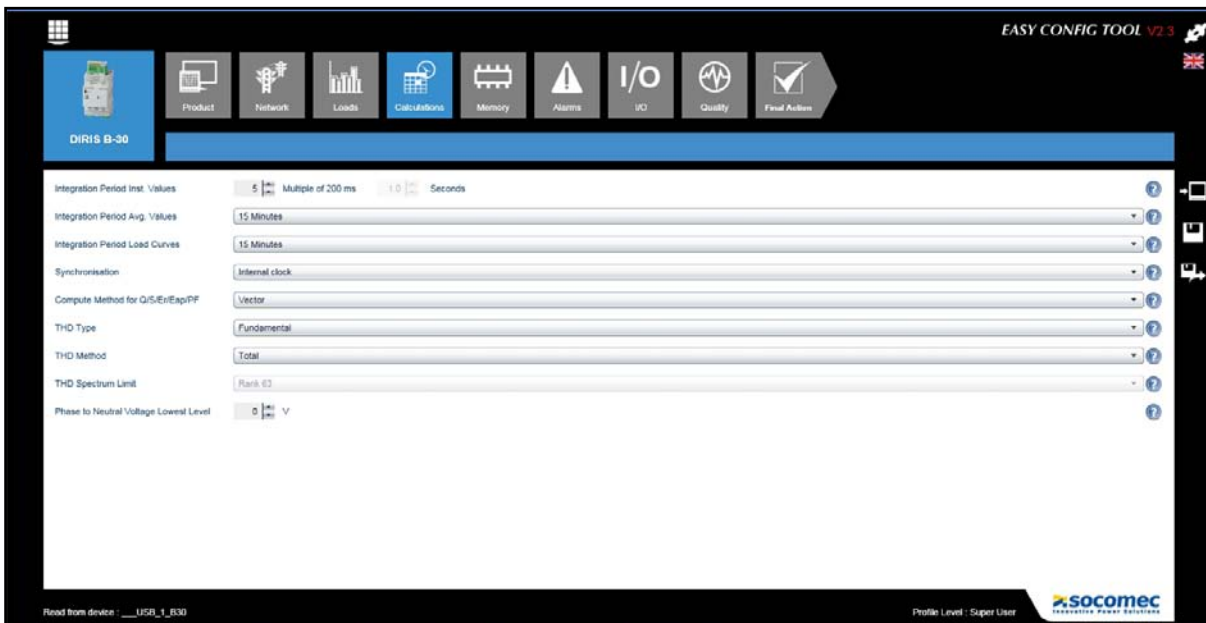

Data acquisition can be synchronised in different ways: communication bus, top synchro or device internal clock.

6.5. Memory Configuration

Two types of variables can be stored:

- **Load curve:** the power values (kW+, kW-, kVar+, kVar-, kVA) are selected to be stored.
- **Values:** the mean values of the electrical quantities (U, I, P, PF, THD...) are selected to be stored.

The **Recording Time** indicated is recalculated automatically according to the integration period chosen in the **Calculations** configuration function.

6.6. Alarms Configuration

Three types of alarm are available:

	Alarm types			
	MEASUREMENTS.	LOGICAL	COMBINED	SYSTEM
I-30				•
I-31				•
I-33				•
I-43		•		•
I-35	•		•	•
I-45	•	•	•	•
U-10				•
U-20				•
U-30	•		•	•

6.6.1. Measurement Alarm

An alarm is generated when the threshold chosen for an electrical quantity (U, I, F, P....) is exceeded. An output relay can be enabled if this threshold is exceeded.

The screenshot shows the 'Alarms' configuration screen in the EASY CONFIG TOOL V2.3. The device is identified as DIRIS B-30. The 'Measure' tab is selected, showing settings for eight measurement alarms. The settings are as follows:

- Measure Alarm 1:** Alarm Activation: Yes
- Measure Alarm 2:** Category: Current
- Measure Alarm 3:** Based On: Instantaneous
- Measure Alarm 4:** Parameters: I1
- Measure Alarm 4:** Measure Point: Load 1
- Measure Alarm 5:** Alarm Upper Threshold: 600.000 A
- Measure Alarm 6:** Alarm Lower Threshold: 200.000 A
- Measure Alarm 7:** Alarm Hysteresis: 0.0 %
- Measure Alarm 7:** Alarm Startup Delay: 0 Multiple of 500 ms, 0.0 Seconds
- Measure Alarm 8:** Alarm Dropout Delay: 0 Multiple of 500 ms, 0.0 Seconds
- Criticality:** Information
- Acknowledgement Method:** Auto
- Input Used for Acknowledgement:** Not Used
- Output:** Not Used

The interface includes a top navigation bar with icons for Product, Network, Loads, Calculations, Memory, Alarms, I/O, Quality, and Final Action. The bottom status bar shows 'Read from device: ...USB_1_B30' and 'Profile Level: Super User'.

6.6.2. Logic Alarm

An alarm is generated if a logic input changes state. An output relay can be enabled jointly.

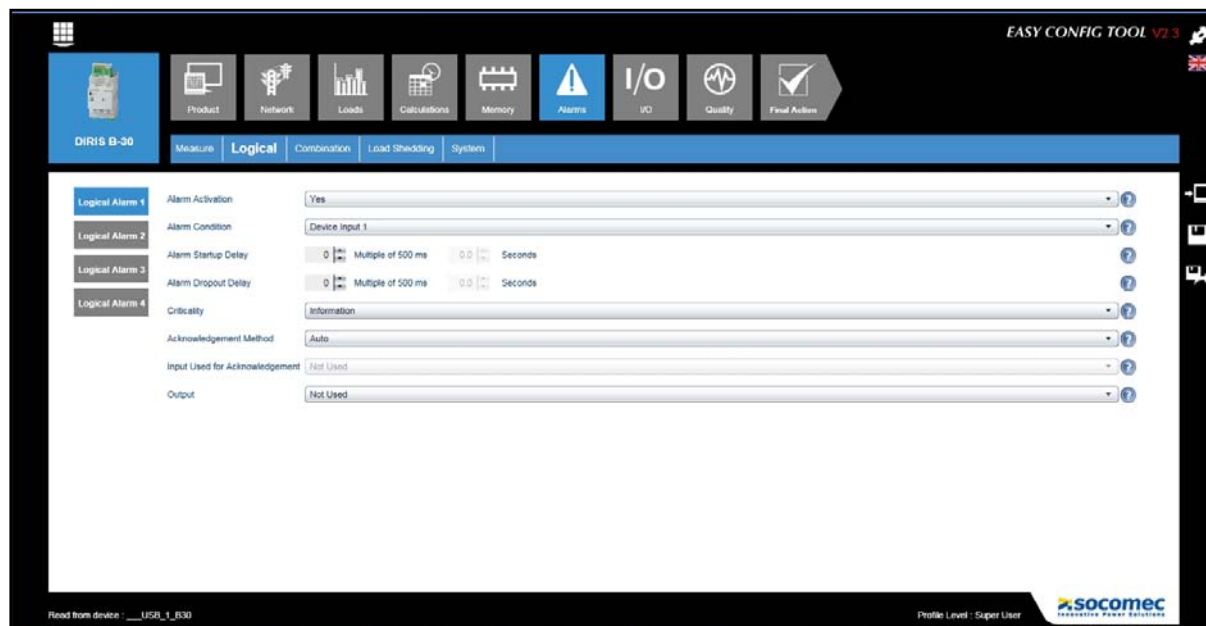

6.6.3. Combination Alarm

An AND/OR logic combination of elementary alarms is created. For example: an alarm is generated if an electrical quantity exceeds a set threshold AND a logic input changes state.

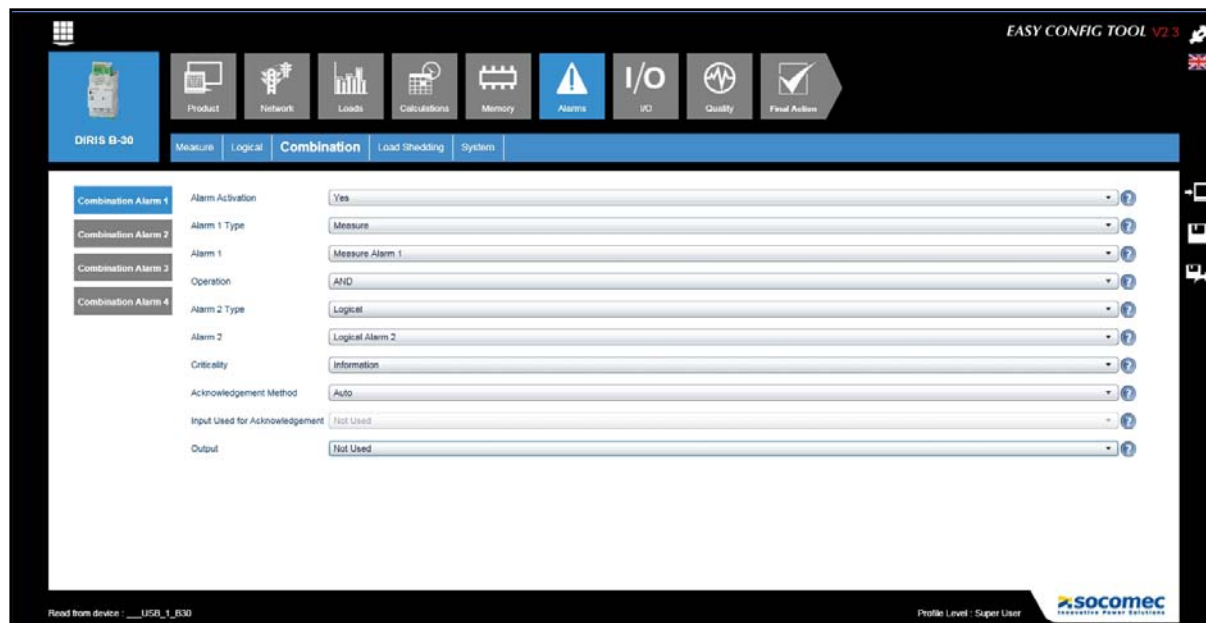

6.6.4. Load Shedding Alarm

The alarm is generated according to the evolution of the predictive power if the latter exceeds a chosen threshold. The alarm status will be checked only at the next top synchro.

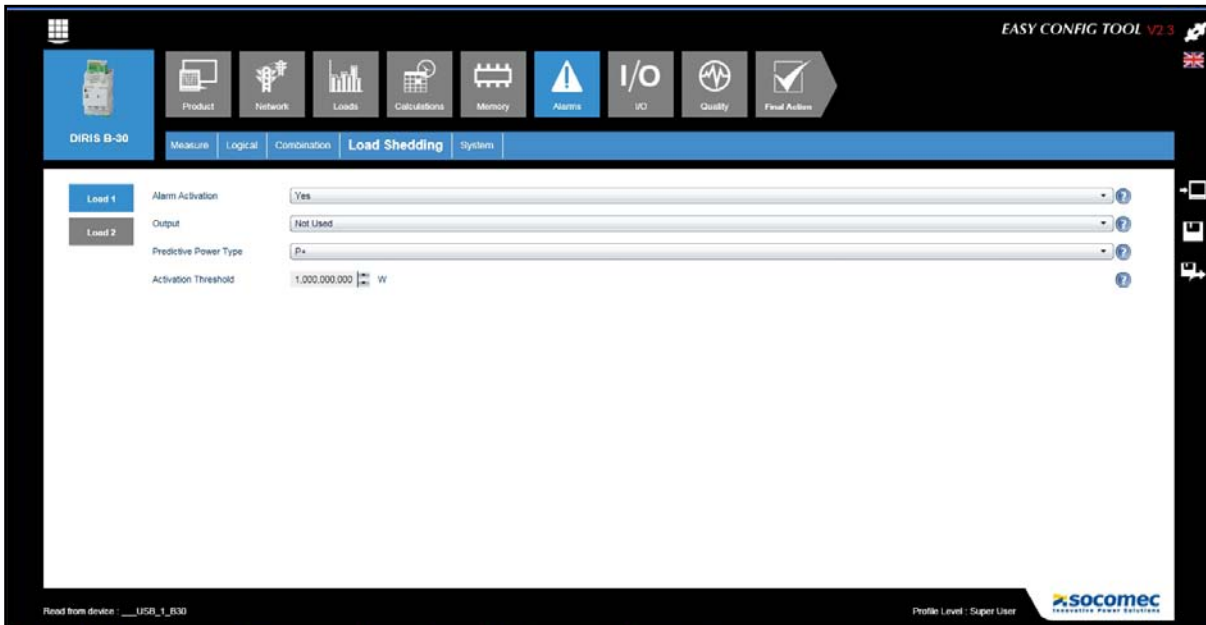

Note: For DIRIS B-30 and DIRIS Digiware, the [Alarms](#) function is described in detail in their respective manuals.

6.7. I/O configuration

This function allows you to set the [Inputs/Outputs](#) present on the device during configuration.

For digital inputs, the mode is selected from binary state, pulse meter, top synchro or change of state of a switching device.

Note: The presence of digital or analogue inputs/outputs depends on the devices and their options.

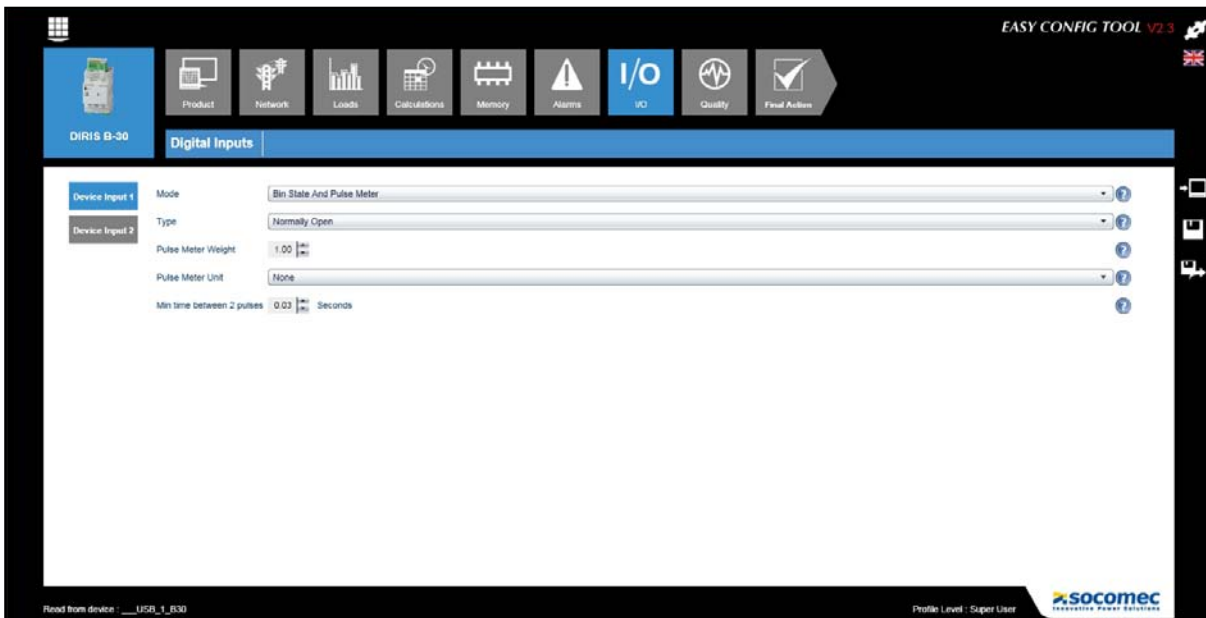

6.8. Quality Configuration

The threshold and the hysteresis of the [EN50160](#) quality events (voltage dips, surges and cut-offs) and of [Current Overload](#) events are configured on this screen.

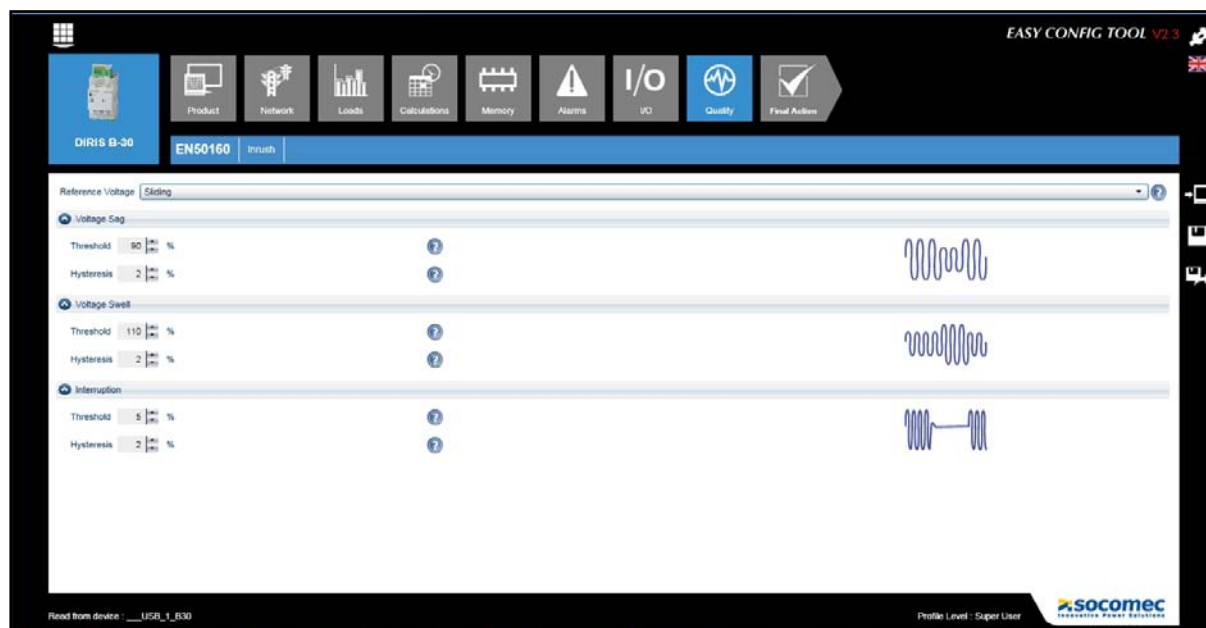

6.9. COM Module Configuration

This function allows you to configure the communication modules (Modbus, PROFIBUS, BACnet) option of the DIRIS B-30.

6.10. Final action

Once all the configurations have been completed for the selected device, the user has several options at his disposal:

- To record the configuration as a file
- To export it as a spreadsheet file in ".csv" format
- To send the configuration directly to the device for immediate application



Note: these actions can also be performed at any time, using the short-cuts on the right of the screen.

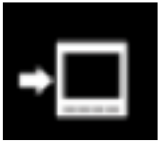

Send directly to the device for immediate application



Record as a file



Export as a spreadsheet file in ".csv" format

Incorrect configuration

If one or more steps of the configuration are incorrect (see example in the chapter “6.2. Electricity Network Configuration”, page 13), they will be listed at the time of recording the configuration. They must be corrected to allow the configuration to be recorded.

The screenshot shows the EASY CONFIG TOOL V2.3 interface. At the top, there is a navigation bar with icons for Product, Network, Loads, Calculations, Memory, Alarms, I/O, Quality, and Final Action. Below this is a table with the following data:

Error	Section Name	Error Level	Field
Nominal Voltage should be between 100 to 520	Network	Error	Nominal Voltage

At the bottom left, it says "Read from device : Product_5(00174AB305A4903)". At the bottom right, it says "Profile Level : Super User" and the Socomec logo.

7. CONFIGURATION OF THE DIRIS G GATEWAY

The configuration of the DIRIS G communication gateways involves some specific aspects described below.

7.1. IP address

By default, the IP address of the DIRIS G gateway is 192.168.0.2, its subnet mask is 255.255.255.0 and its Modbus address is 1. These parameters may be changed by the user.

The address of the router to which the gateway is connected must also be entered in the section [IP Configuration / Gateway](#).

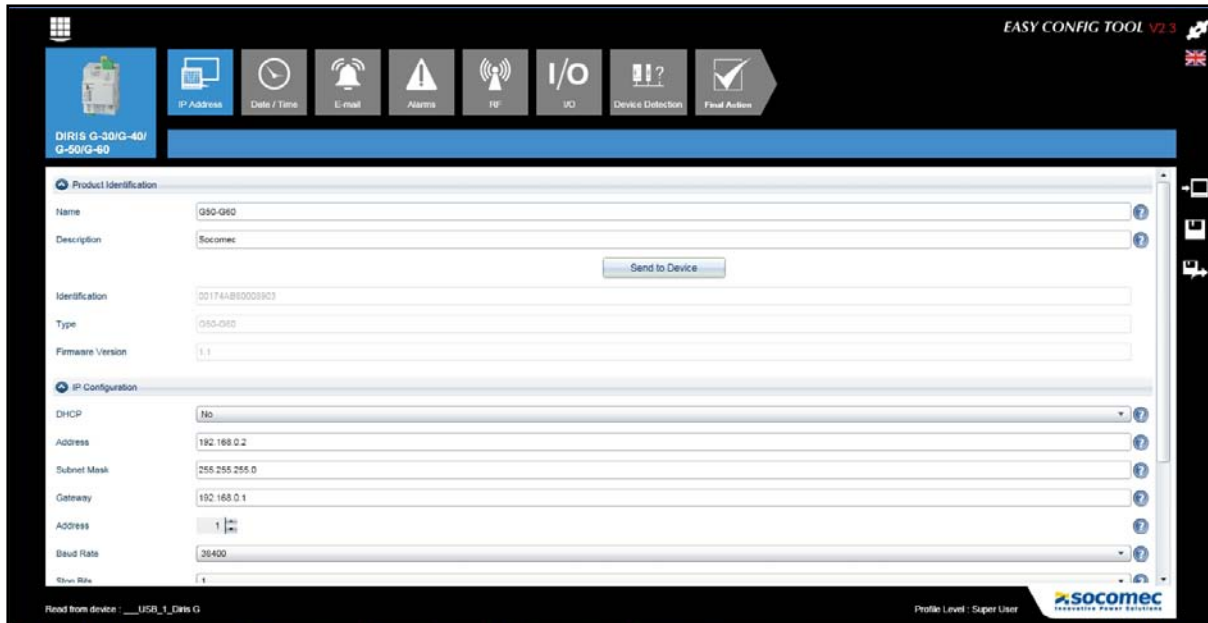

Others communication parameters RS485 Modbus, BACNET, SNMP (according the device) are also configurable via this menu.

7.2. Date / Time

Different modes are possible for setting the date and time.

- SNTP (Simple Network Time Protocol): This is a protocol that allows the local time of the devices to be synchronised with a time reference, by means of a computer network. The parameters of the SNTP server must be entered. The time obtained will be transmitted periodically or manually to the devices connected to the gateway.
- Manual synchronisation: The gateway time is synchronised with the time of the user's PC.

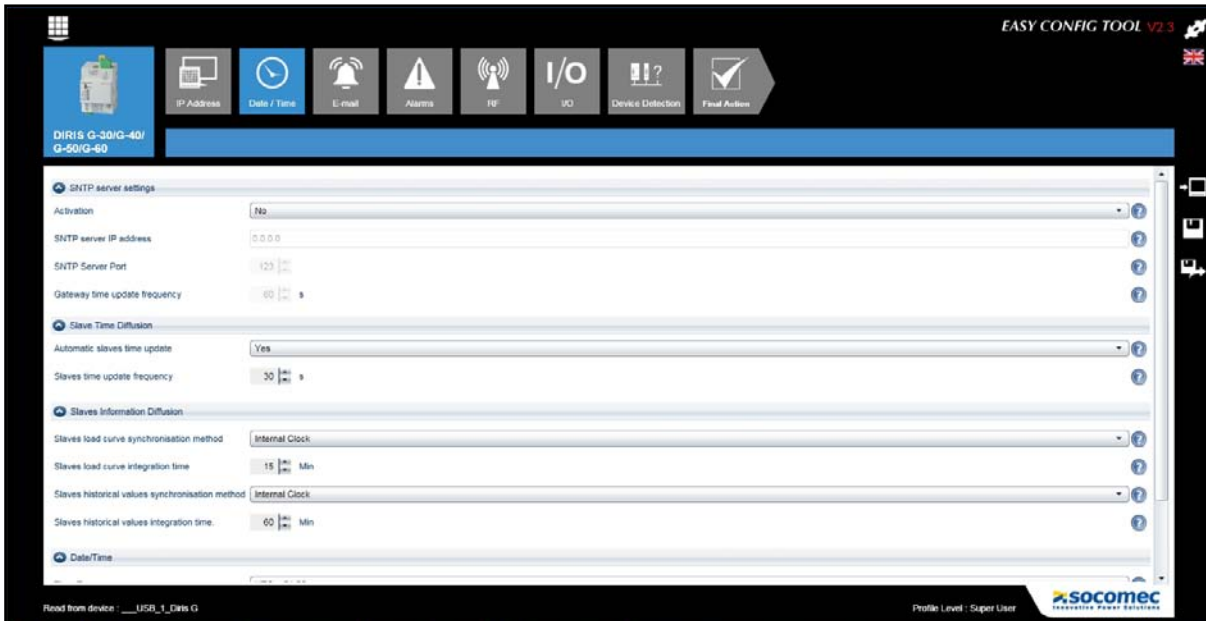

[Synchronisation method for slave load curves](#): If [Internal Clock](#), [Input](#) or [Com](#) is chosen, the slaves are synchronised with the DIRIS G gateway. They must be configured in [Com](#) mode and with the same integration time as the DIRIS G. This setting is performed in the [Calculations](#) menu (see page 14) of each of the slaves.

[Integration time of the slave historic values](#): The registration frequency of the energy index for the consumption readings of all the slaves is chosen in this section.

7.3. E-mail

SMTP (Simple Mail Transfer Protocol) is a communication protocol used to transfer e-mail to the e-mail servers.

This protocol available on the DIRIS G gateway allows an e-mail alert to be sent if an alarm has been generated. The parameters of the SMTP server and of the e-mails must be entered beforehand. All the alarms or only those defined as critical can be sent by e.mail.

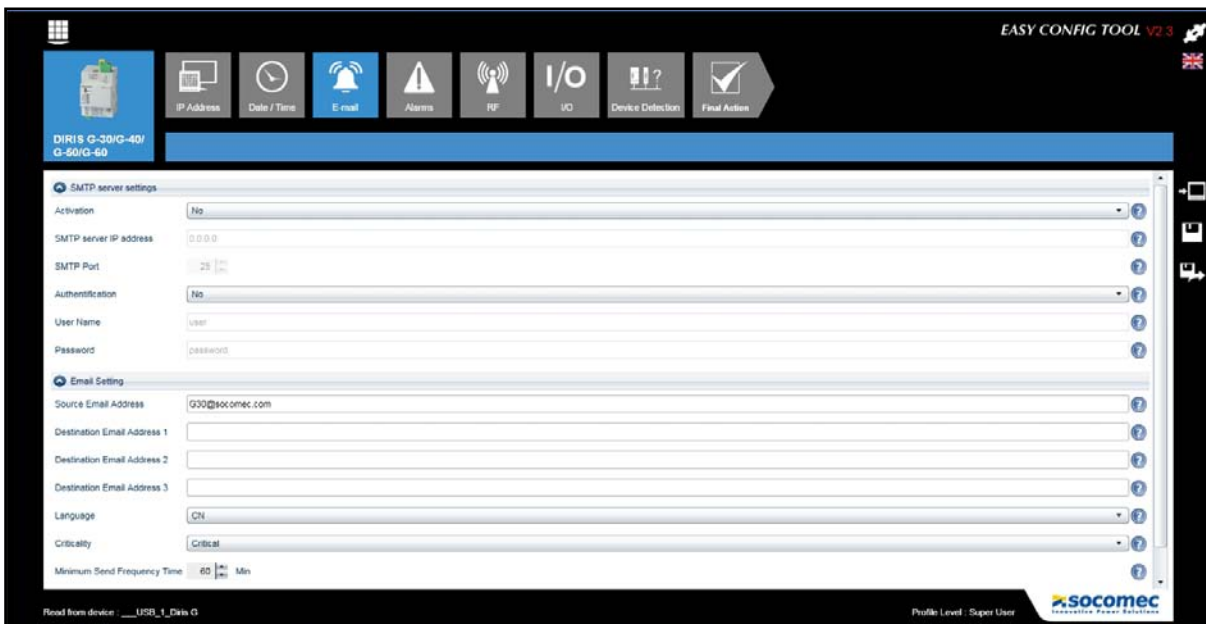

7.4. Multi-tariff

Some devices feature the multi-tariff function:

- DIRIS B-30
- DIRIS Digiware I-31, I-35, I-45, I-61

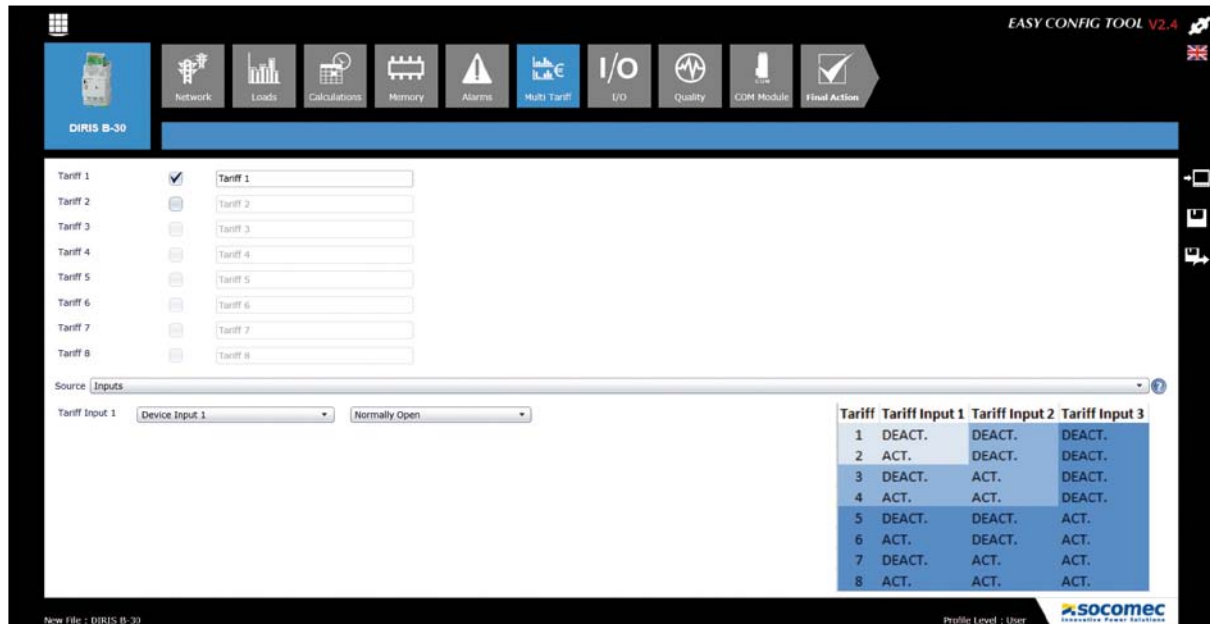

You can manage their multi-tariff metering via:

- Digital inputs (DIRIS B-30 and DIRIS Digiware I-45) => configuration [Source: Inputs](#)
- Upstream communication (RS485 and/or RF) e.g. via a DIRIS G gateway => configuration [Source: COM](#)

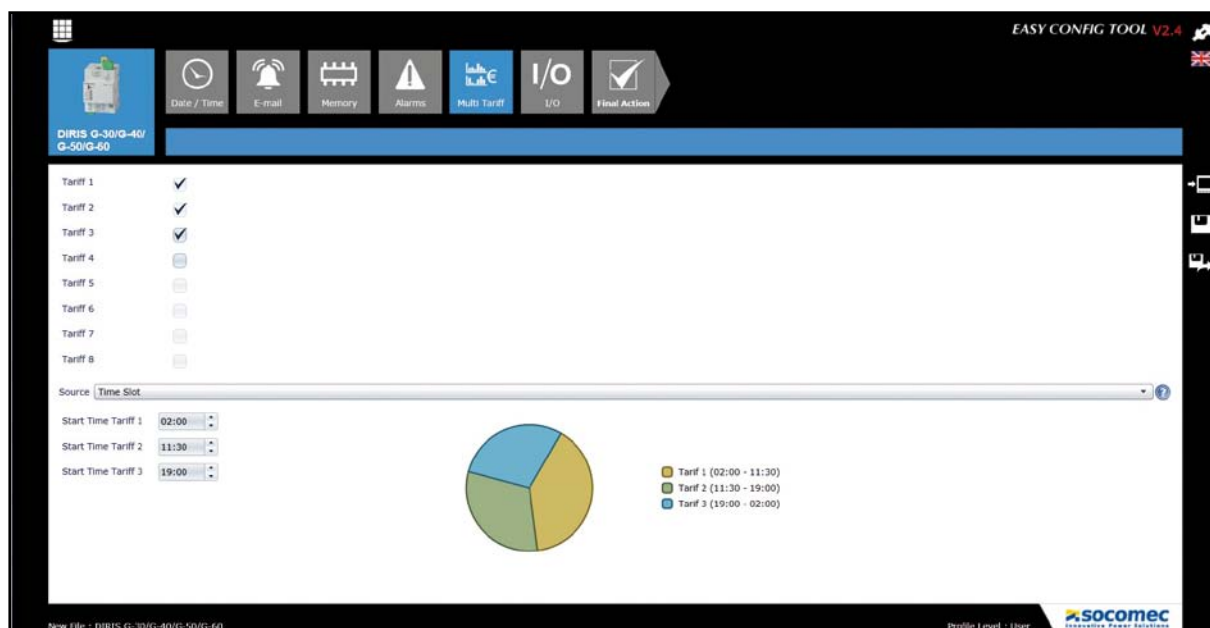

- You can manage the multi-tariff settings via the DIRIS G gateway for all devices connected downstream via:
 - The upstream communication (command received by the DIRIS G gateway via Ethernet)
 - Digital inputs (command received by auxiliary contacts)
 - Timed programming (preset timings)

These time changes are applied to all DIRIS Digiware and DIRIS B slaves.

7.5. Radio-frequency (RF)

RF communication is available on the DIRIS G-40 and DIRIS G-60 gateways.

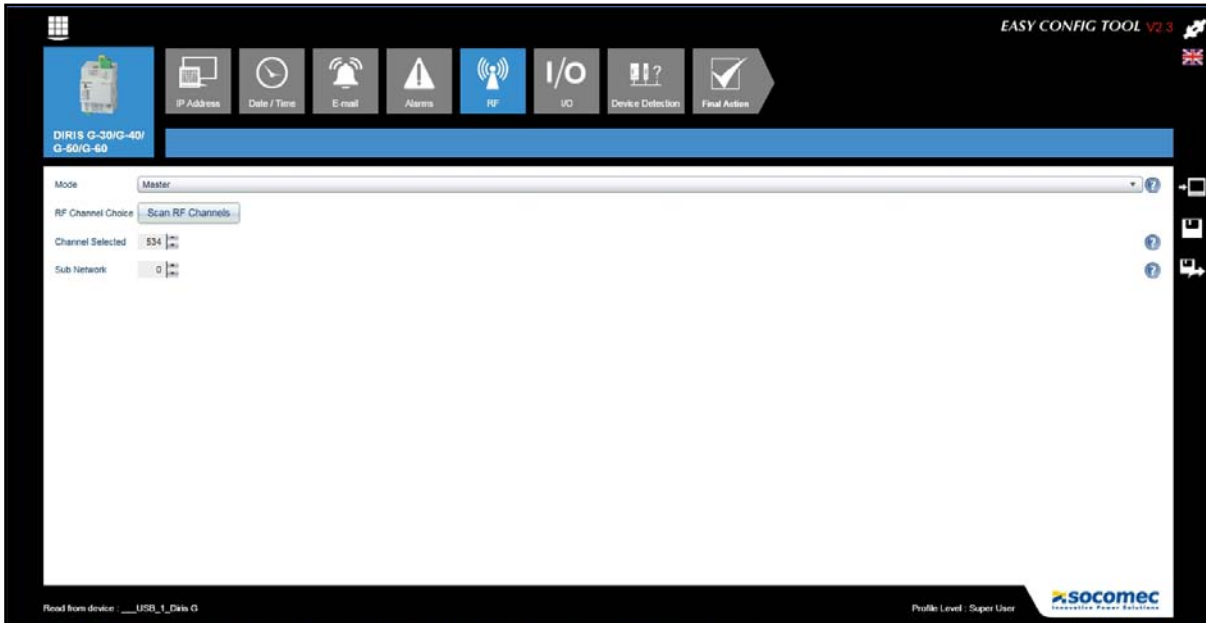

[Scan RF Channels](#) allows you to identify the communication channels available and the maximum number of devices loaded by following the channel.

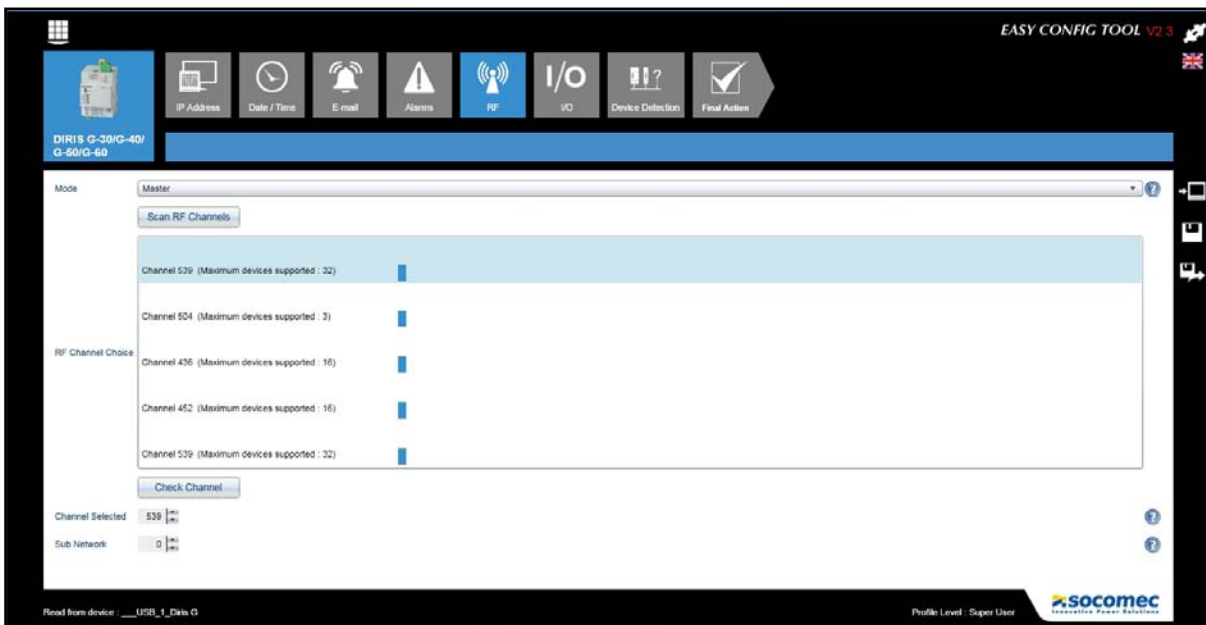

The channel and the subnet chosen for the DIRIS G gateway and the DIRIS B-30 must be the same.

7.6. Device detection

7.6.1. Automatic auto-addressing

This function allows auto-addressing of the devices. The auto-addressing mode allows automatic assignment of addresses to the devices connected to the gateway. This mode is compatible only with DIRIS B-30 and DIRIS Digiware. Addresses will be assigned by hand on the other devices (DIRIS A, COUNTIS and ATYS).

To assign the addresses of DIRIS B-30 and DIRIS Digiware, run the [New Discovery](#) procedure and hold down for three seconds the button on the front of each connected product so that its fixed LED starts blinking:

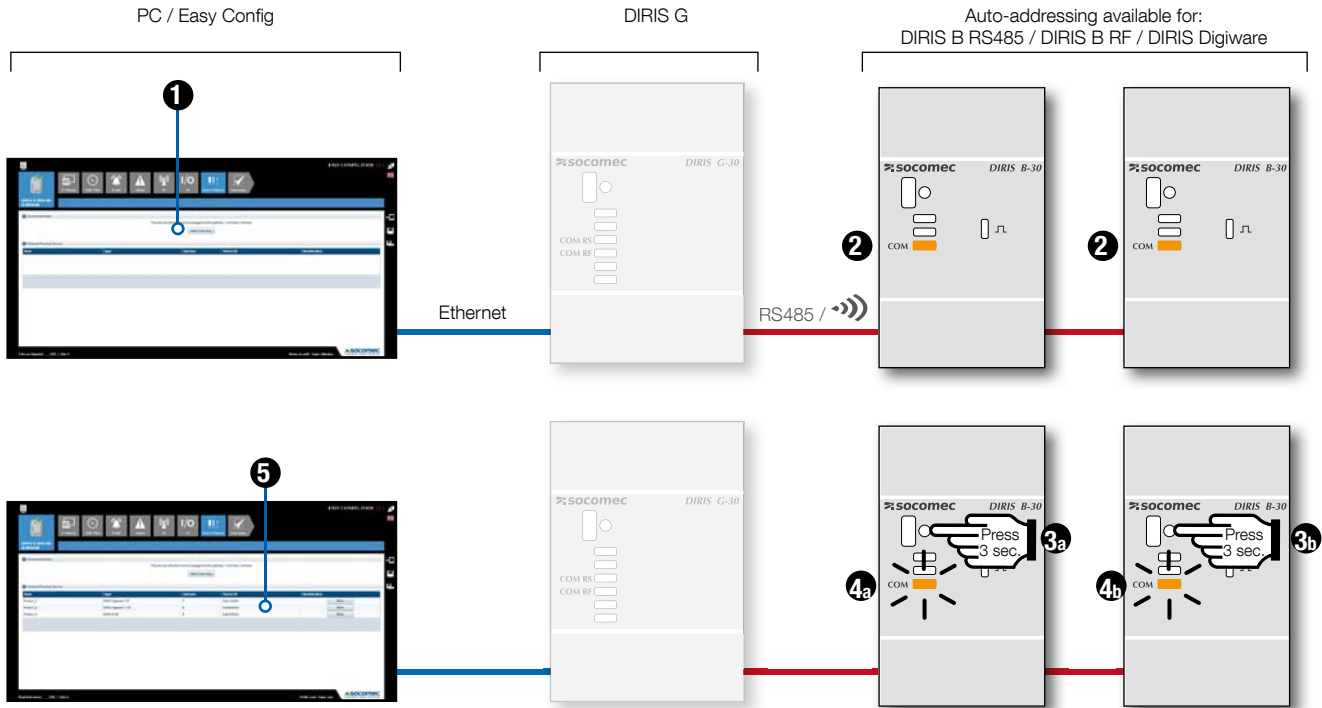

Once the devices have been recognised, their identification ([Device ID](#)) and the address assigned by the auto-addressing procedure or by hand are listed in the [Detected Running Devices](#) section.

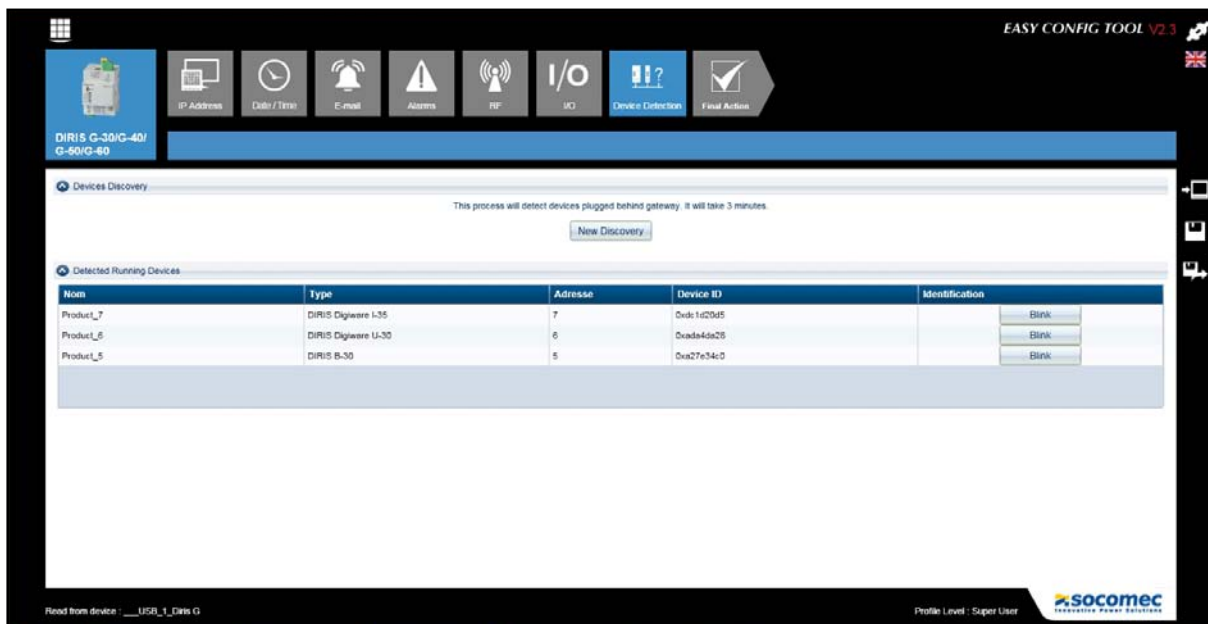

7.6.2. Semi-automatic auto-addressing

When the products are in conflict with an identical address in the [Detected Conflicted Devices](#) section, a new address can be assigned to them by modifying the content of the [Address](#) field.

EASY CONFIG TOOL V2.3

DIRIS G-30/G-40/
G-50/G-60

IP Address | Date / Time | E-mail | Alarms | RF | I/O | Device Detection | Final Action

Devices Discovery
This process will detect devices plugged behind gateway. It will take 3 minutes.
New Discovery

Detected Running Devices

Name	Type	Address	Device ID	Identification
Product_L6	DIRIS Digisire U-30	6	Dvada4da26	Blink

Detected Conflicted Devices

Device ID	Address
Dva27e34c0	7
Dvada1d20d5	7

Send New Addresses

Read from device : G50 | Profile Level : Super User | socomec

EASY CONFIG TOOL V2.3

DIRIS G-30/G-40/
G-50/G-60

Adresse IP | Date / Heure | E-mail | Alarms | RF | Entree/Sortie | Device Detection | Action finale

Devices Discovery
This process will detect devices plugged behind gateway. It will take 3 minutes.
New Discovery

Detected Running Devices

Nom	Type	Adresse	Device ID	Identification
Product_L6	DIRIS Digisire U-30	6	Dvada4da26	Blink

Detected Conflicted Devices

Device ID	Adresse
Dva27e34c0	7
Dvada1d20d5	8

Send New Addresses

À lire sur l'appareil : G50 | Niveau de profil : Super Utilisateur | socomec

When running the [Send New Addresses](#) procedure, the devices will appear in the [Detected Running Device](#) list with their individual and unique address.

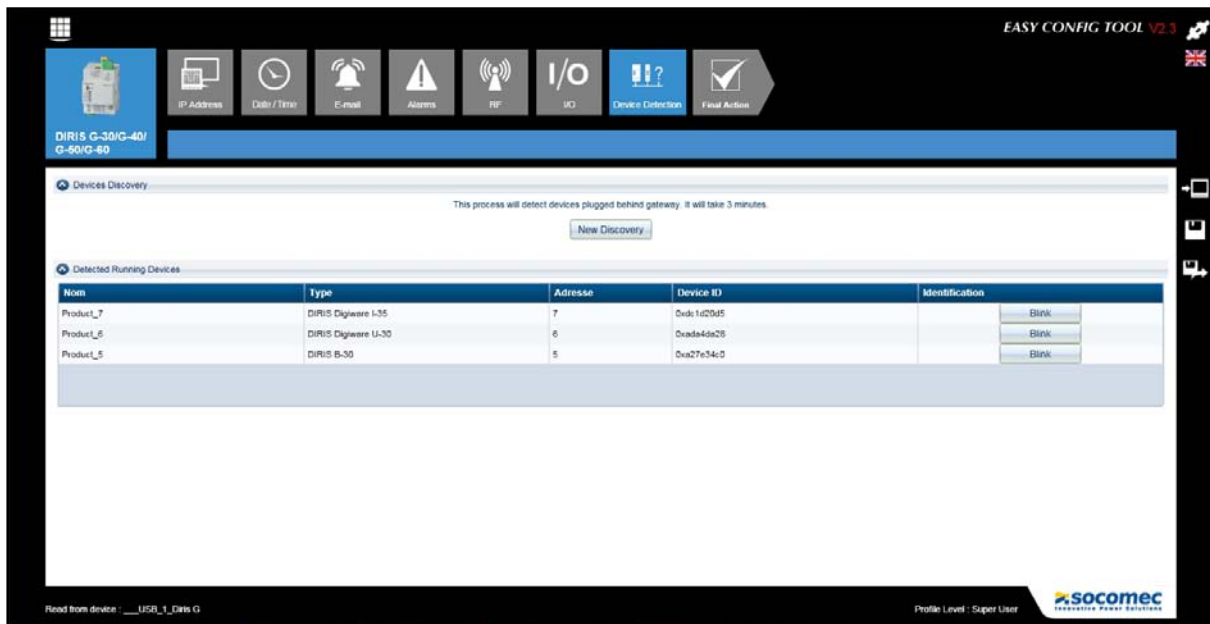

Then, all the auto-detected devices are automatically added to the list of devices in the general menu, without you having to connect each device via USB:

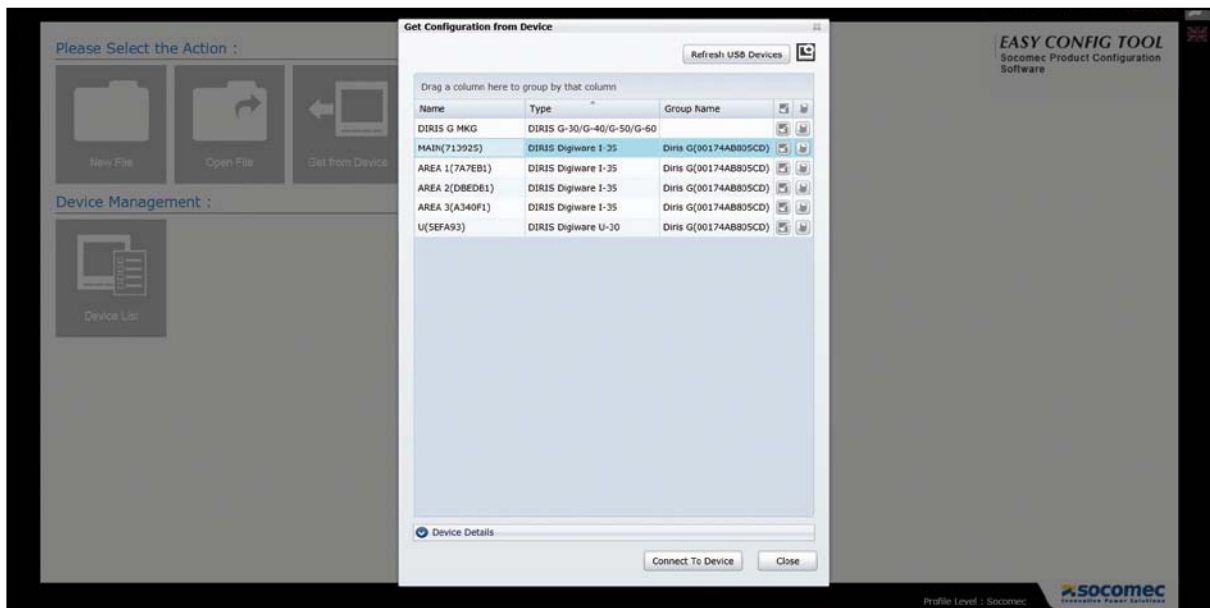

There is no need to connect each device via USB, instead you can do this via the USB and/or Ethernet port on a DIRIS Digiware D display or a DIRIS G gateway.

Via USB

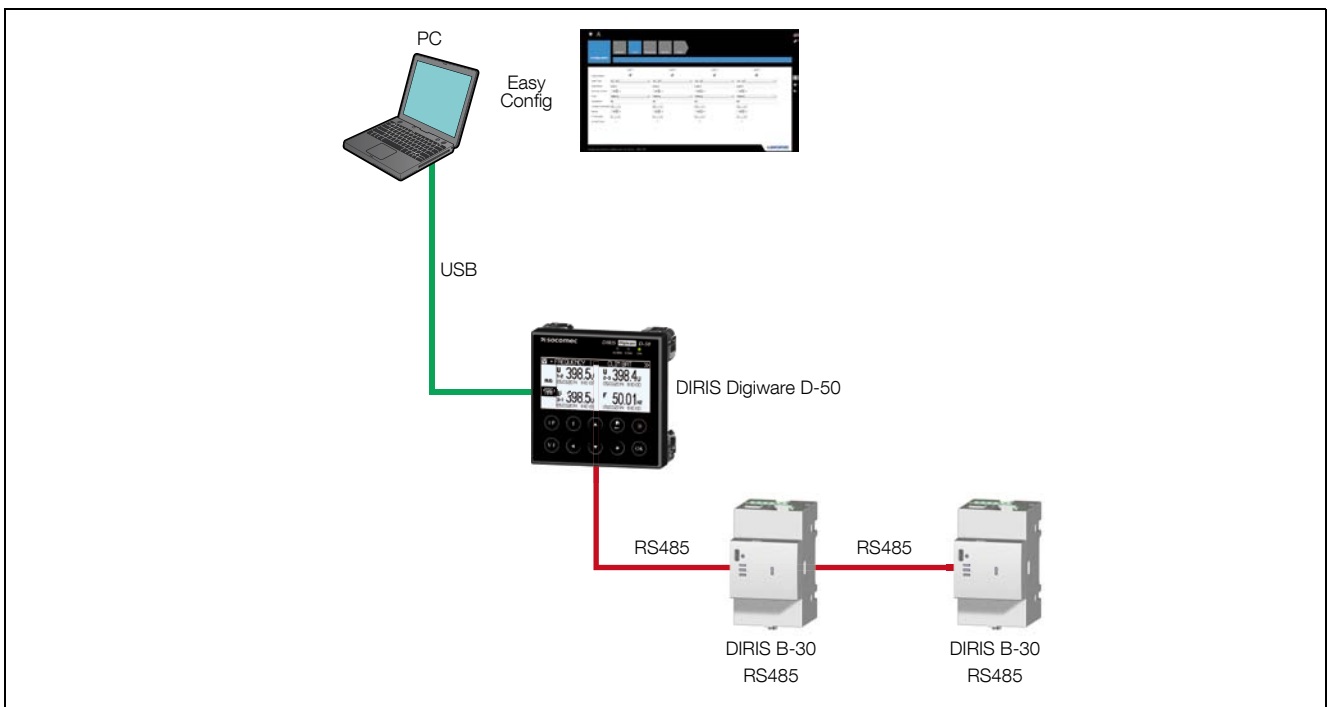
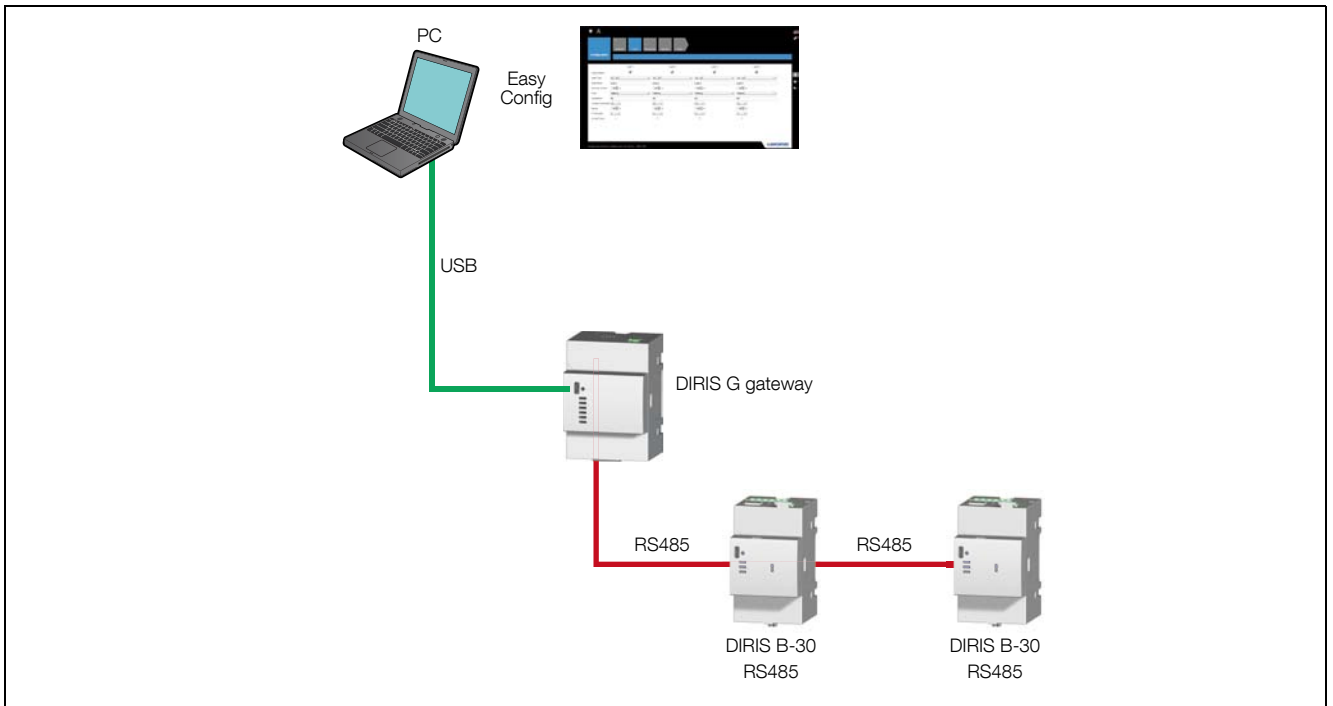

Via Ethernet

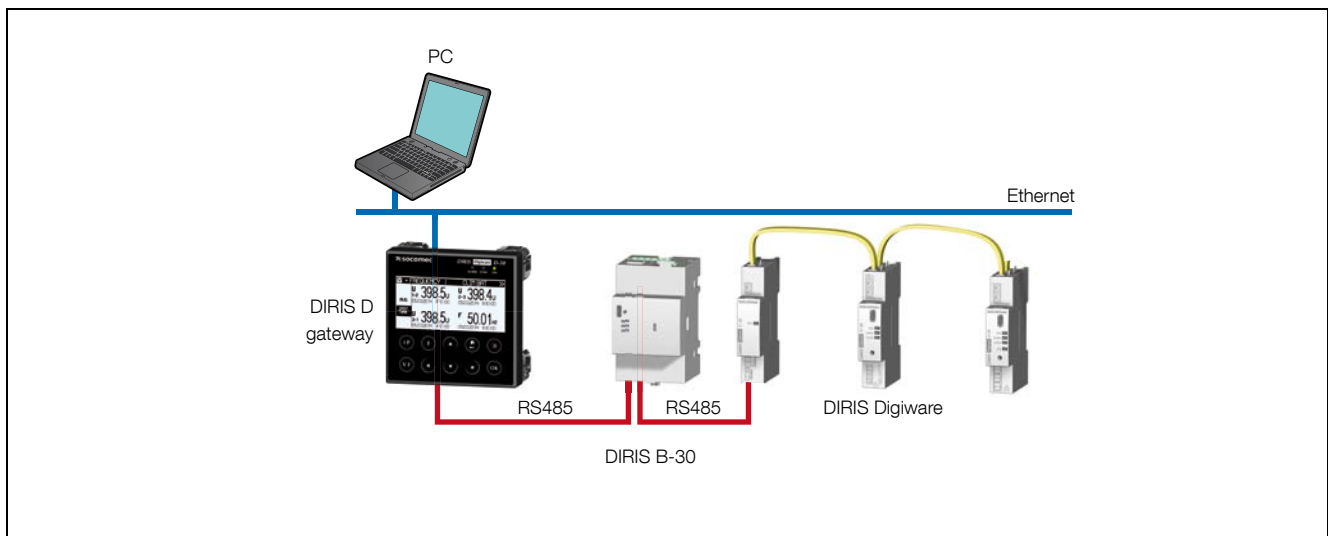
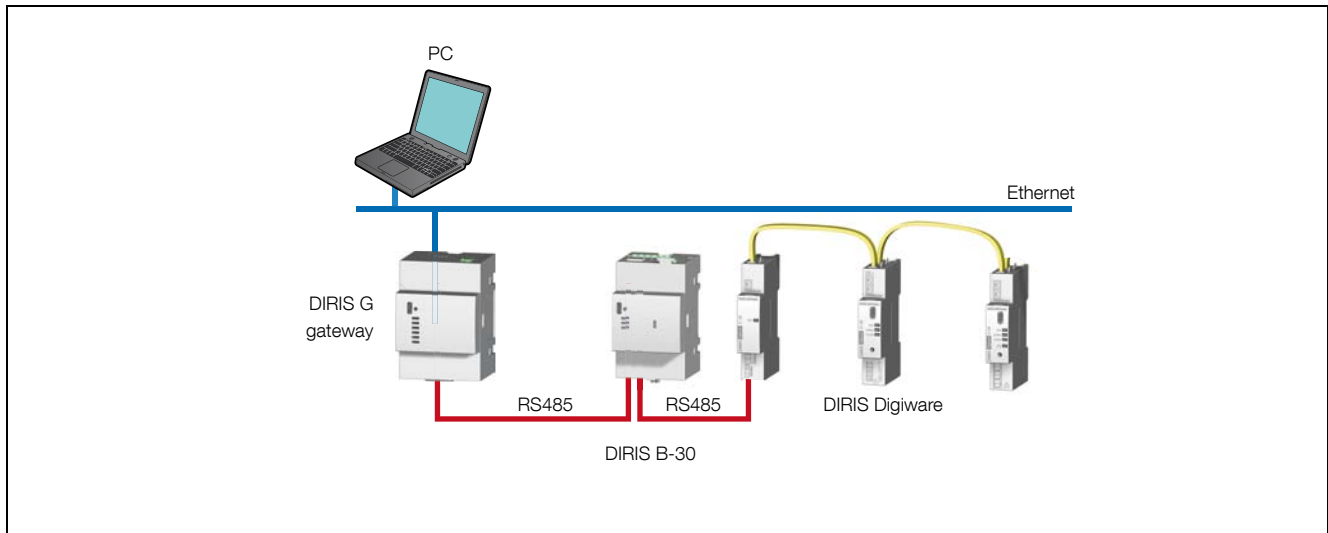

7.7. Final action

Just as for the devices (DIRIS, COUNTIS, ATYS), the configuration can be saved in a file or applied directly to the connected gateway.

8. CONFIGURATION OF THE TRANSFER SWITCH

The example chosen for the following pages is the ATyS p, the screens for ATyS p M will be similar.

8.1. Status and control screen

The screen below will appear once the ATyS has been selected using a User profile. This screen is active only when configuring a product online («Product Connected»). LED representation shows the state of the product while a for line text table includes a status summary in concise language.

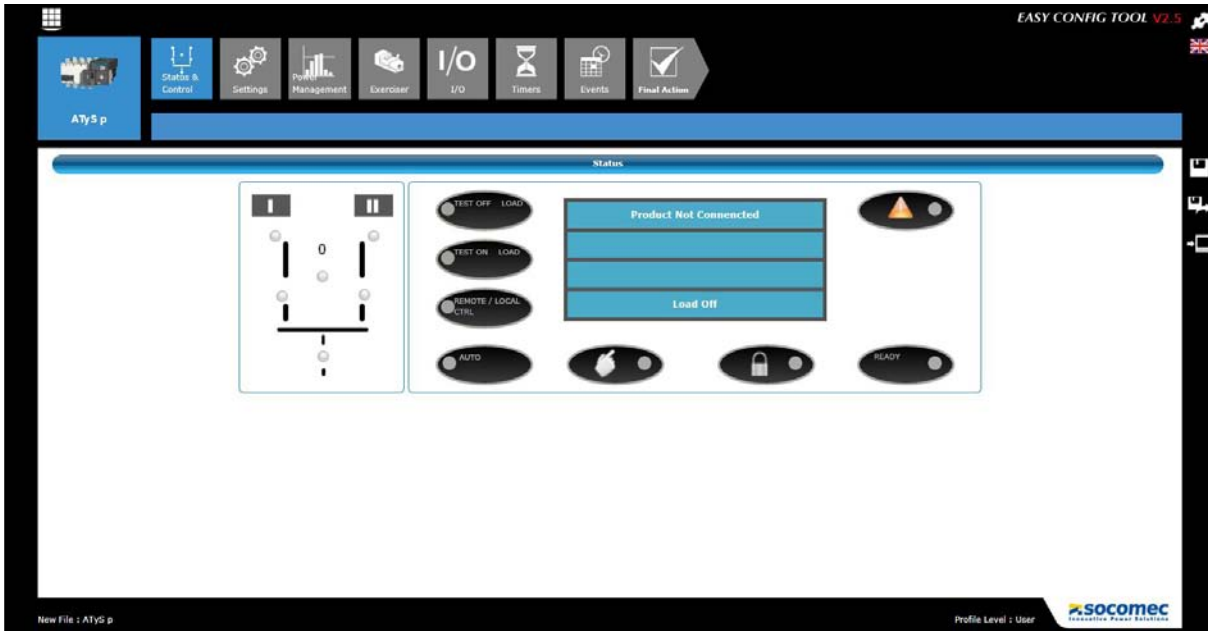

When connected as a Super User in addition to the status information displayed above the user will have access to the «Remote Control» functions of the ATyS. (Refer to the end of this section for details).

8.2. Setting screen 1

This function concerns the electricity network parameters. It allows you to choose the type of network, the rated voltage, the frequency, the neutral position, the phase rotation direction, the characteristics of a possible voltage transformer (only for ATyS p) and the specificities of the installation.

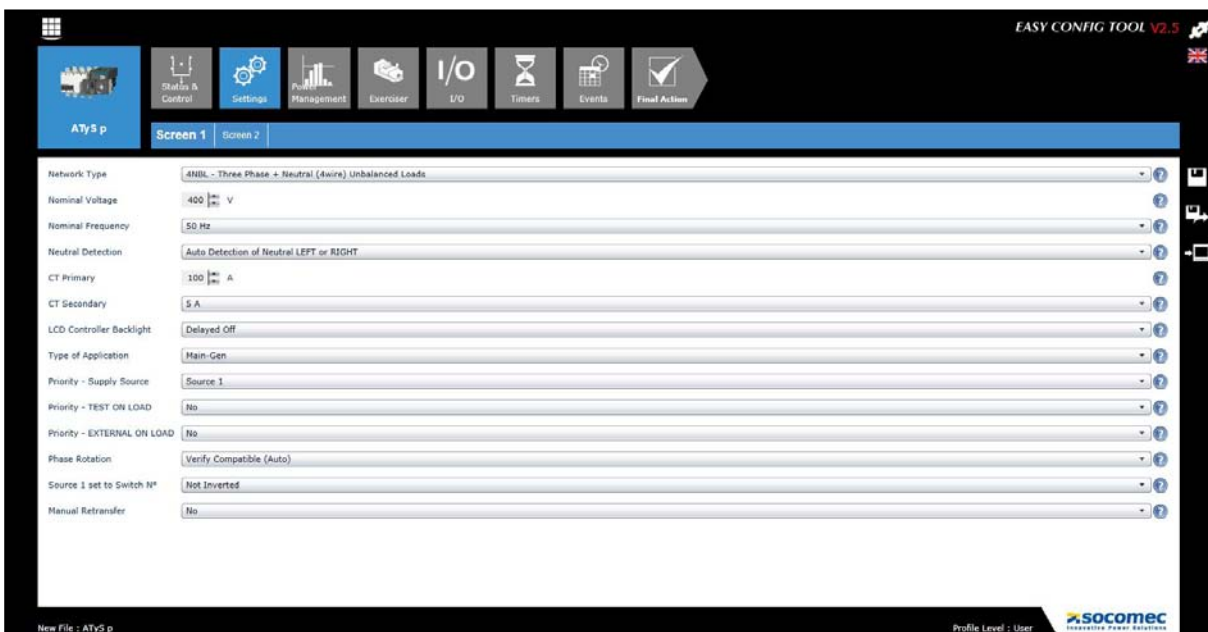

Incorrect configuration:

For the fields where the user has to write a value, if the latter is incompatible with the device, the corresponding field will be displayed in red with an error message. This operating principle applies to all Easy Config screens.

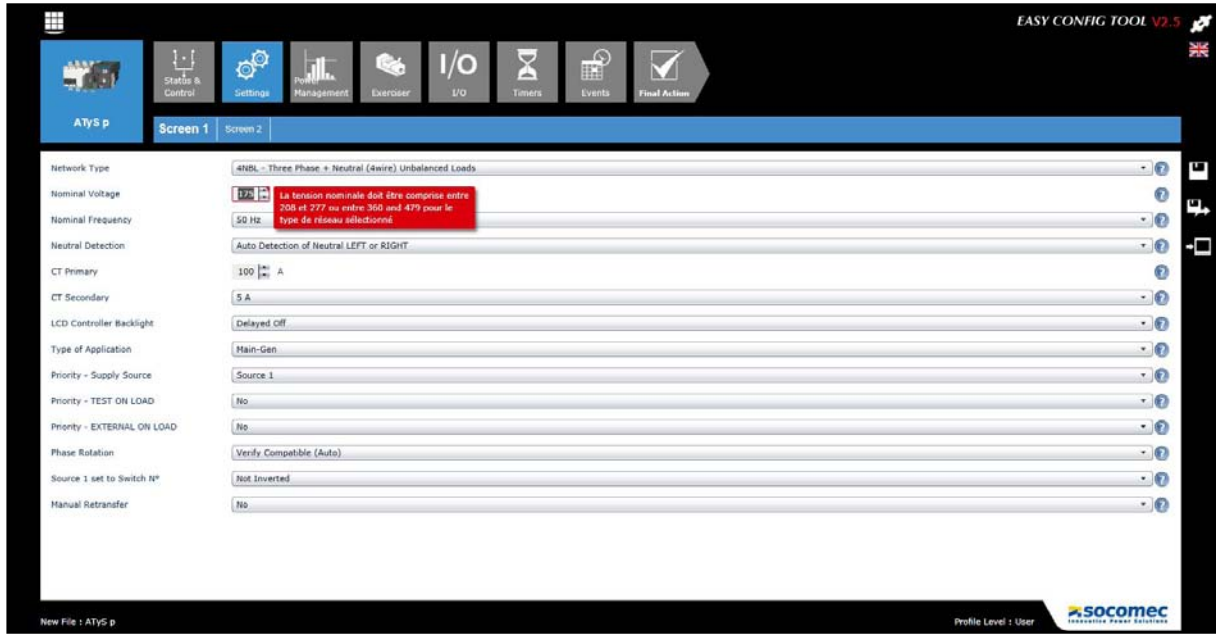

8.3. Setting screen 2

This function allows you to set the voltage and frequency thresholds an hysteresis and voltage unbalance for both sources.

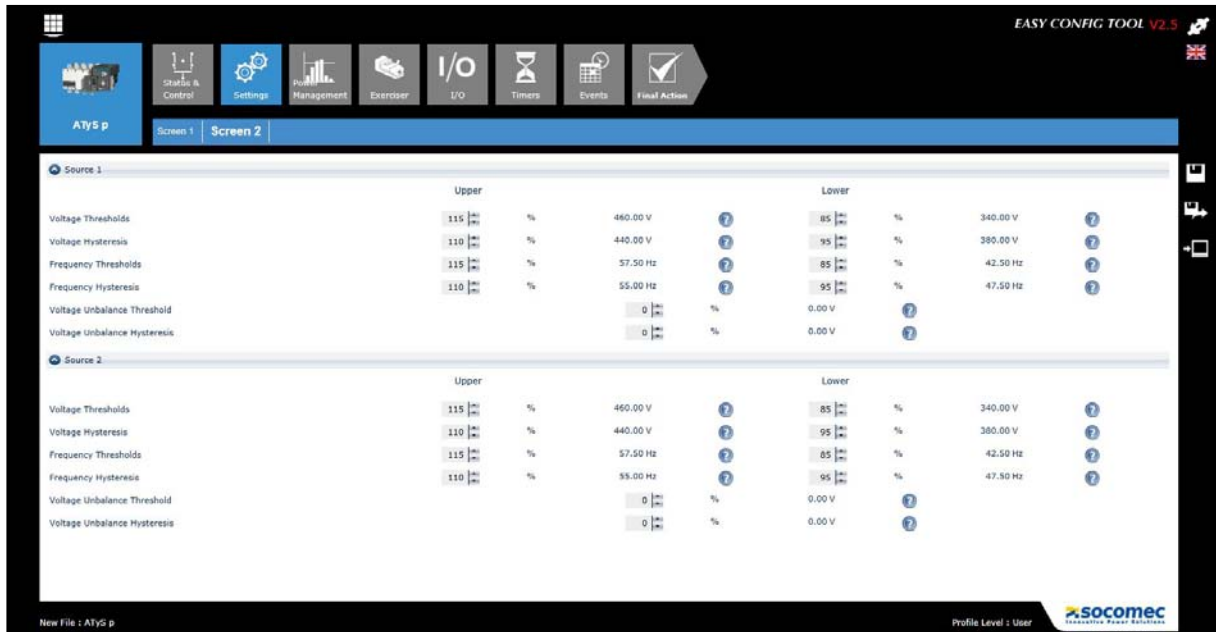

8.4. Power management screen (only available for ATyS p)

Power Management settings are used so as to set the supply ratings for metering purposes (Power bar graph included on the status screen of the Webserver) as well as capacity management through load shedding..

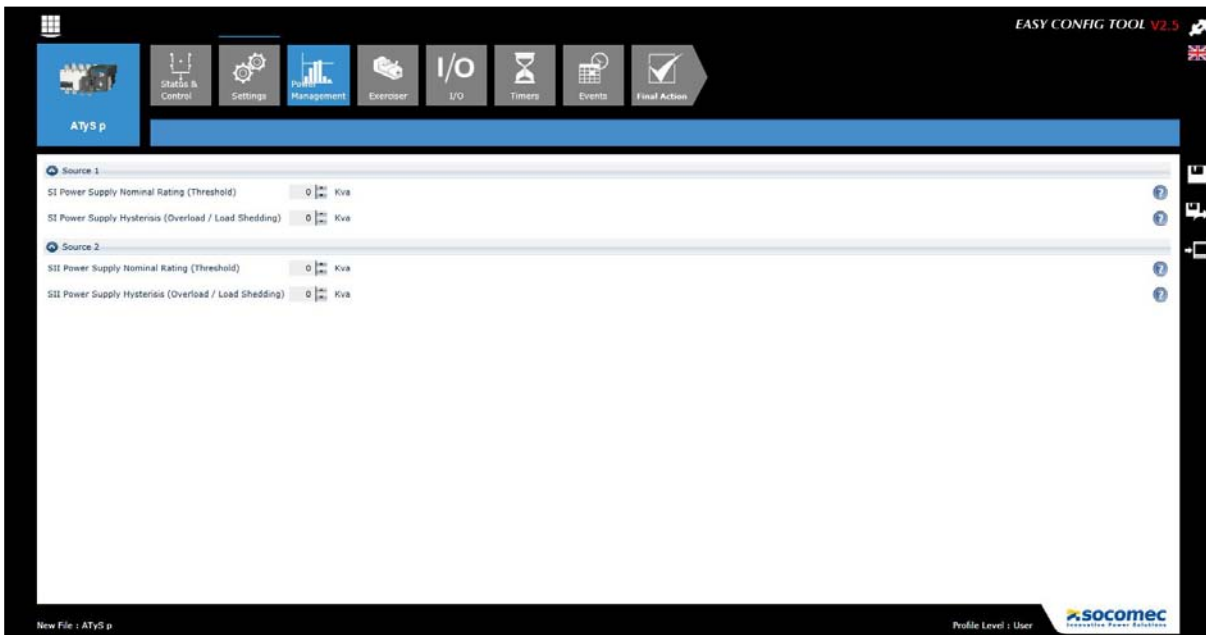

8.5. Engine exerciser screen (only available for ATyS p)

The ATyS p includes a programmable engine exerciser with four independent customizable routines to exercise the engine and Genset. Exercising may be programmed using Easy Config Software or directly through the webserver. It may be carried out with or without loads, on a daily, weekly, bi-weekly monthly or yearly basis. It is also possible to configure non-cyclic exercise runs.

Note 1: Ensure that the TOT and TFT timers are set to UNL when using the Engine Exerciser.

Note 2: The engine exerciser may also be set directly through the built in webserver.

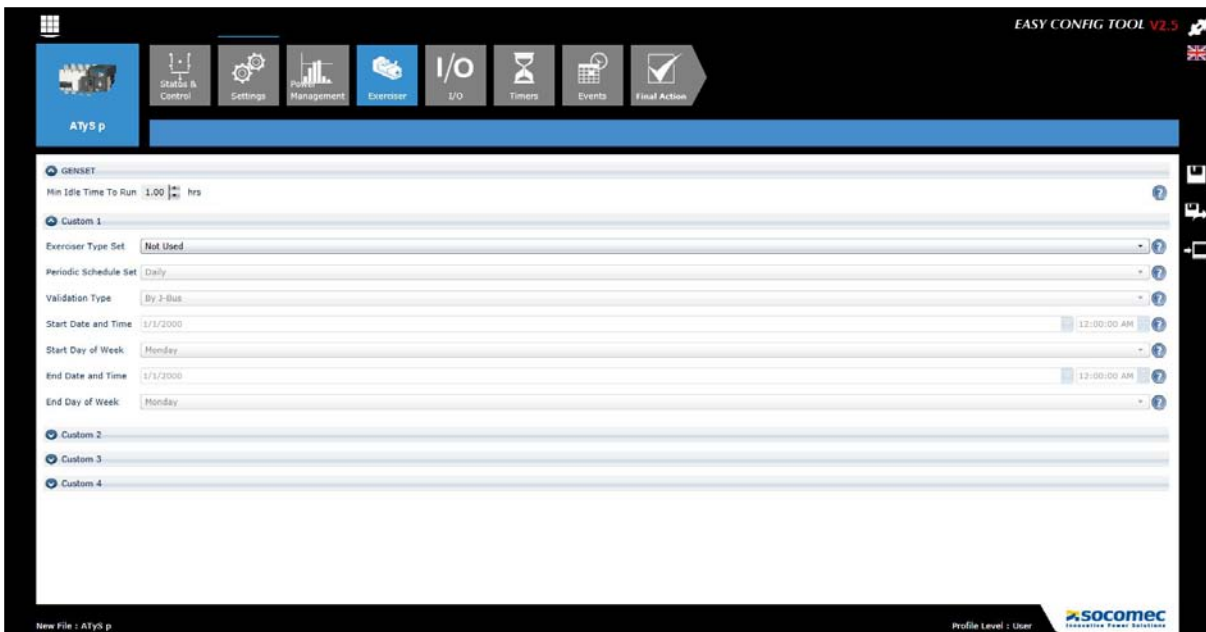

The Genset minimum idle time to run is used to define the minimum time that the Genset must be OFF so as to start an engine exerciser sequence. This time is defined so as to avoid exercising the Genset unnecessarily such as immediately after a start due to a loss of supply.

Configuration may be done on one as well as on all four custom settings. When not using a custom setting simply configure as "Not Used".

8.6. Inputs screen

All the inputs may be configured as normally open or normally closed contacts through the software as shown below.

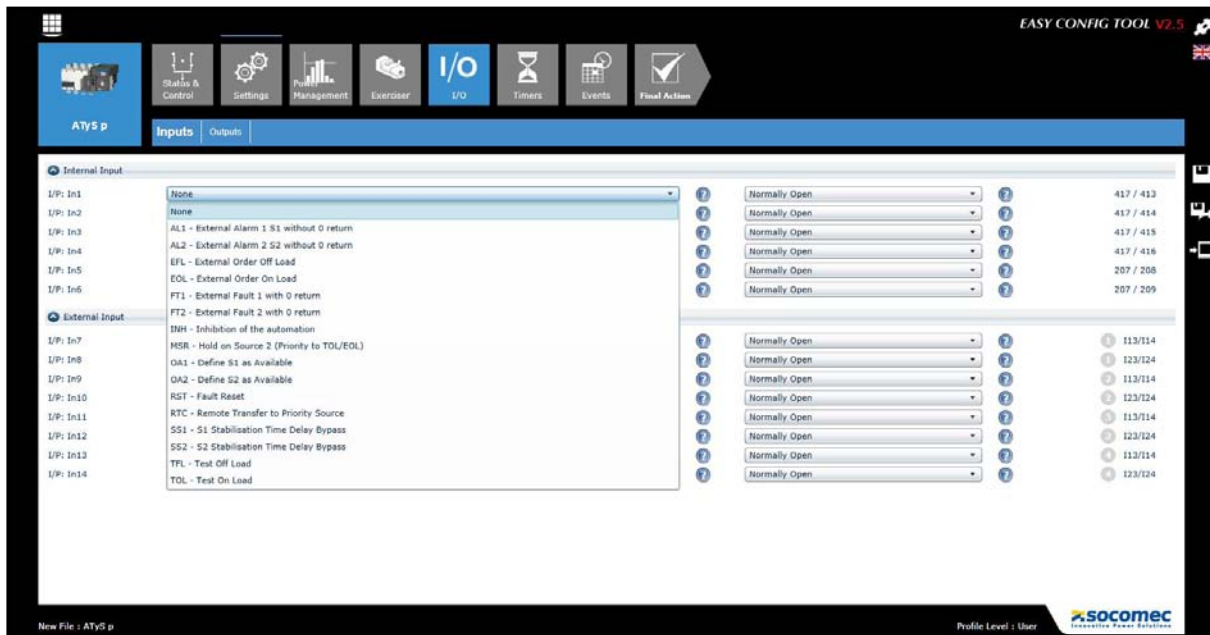

8.7. Outputs screen

All inputs can be configured as normally open or normally closed contacts via the software for ATyS p, for ATyS p M they are fixed as normally open..

The factory setting of the output included with the standard ATyS p is set as Product Available, it will be open when the product is not powered.

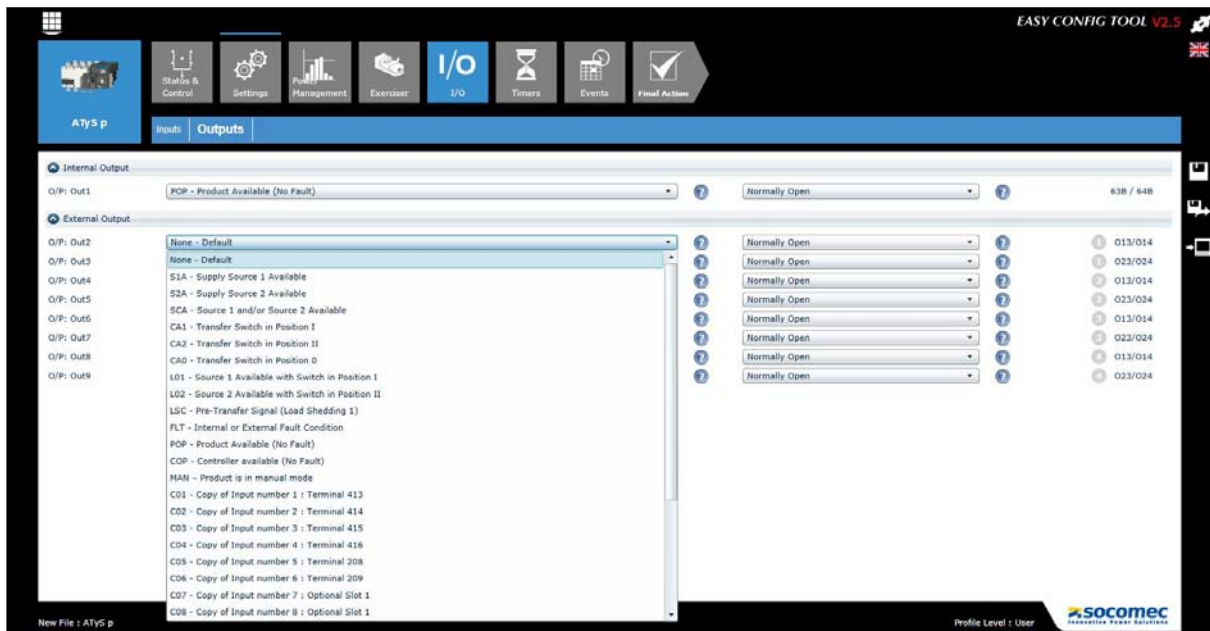

8.8. Timers screen 1

Loss and return timers of sources 1 and 2 as well as the zero dead band timer can be configured via this screen.

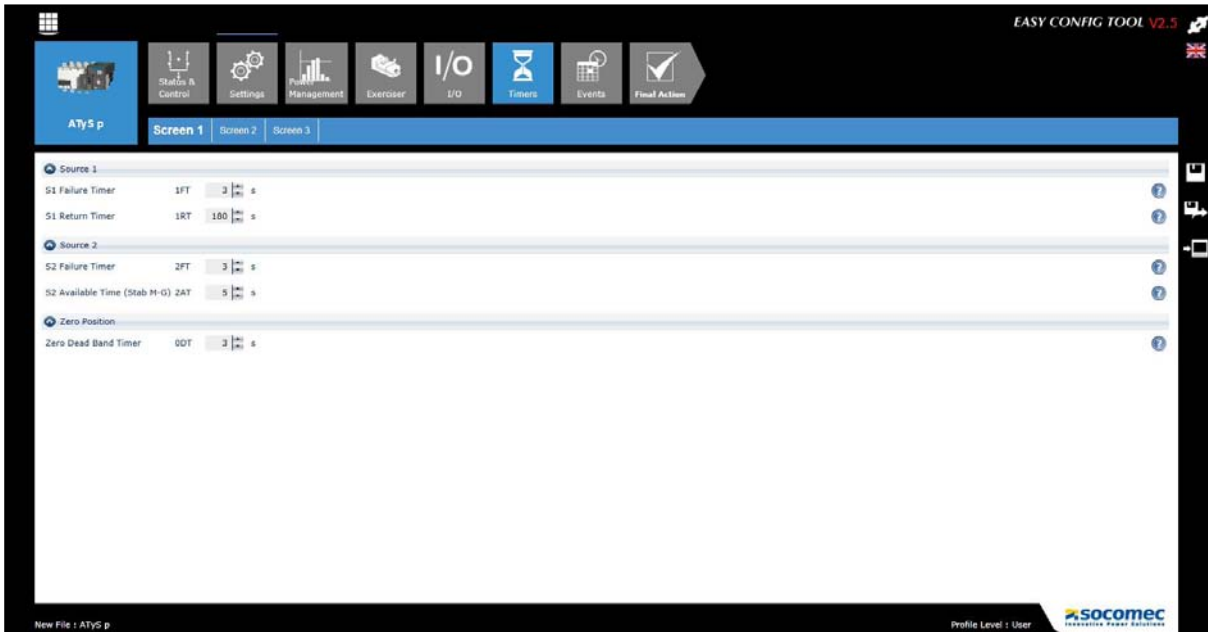

8.9. Timers screen 2

Timers screen 2 is applicable and only available for Main – Gen applications. When the “Type of Application” configuration under “Settings” is set to Main – Main, this screen will be hidden.

It allows configuration of timers linked to external on and off load orders.

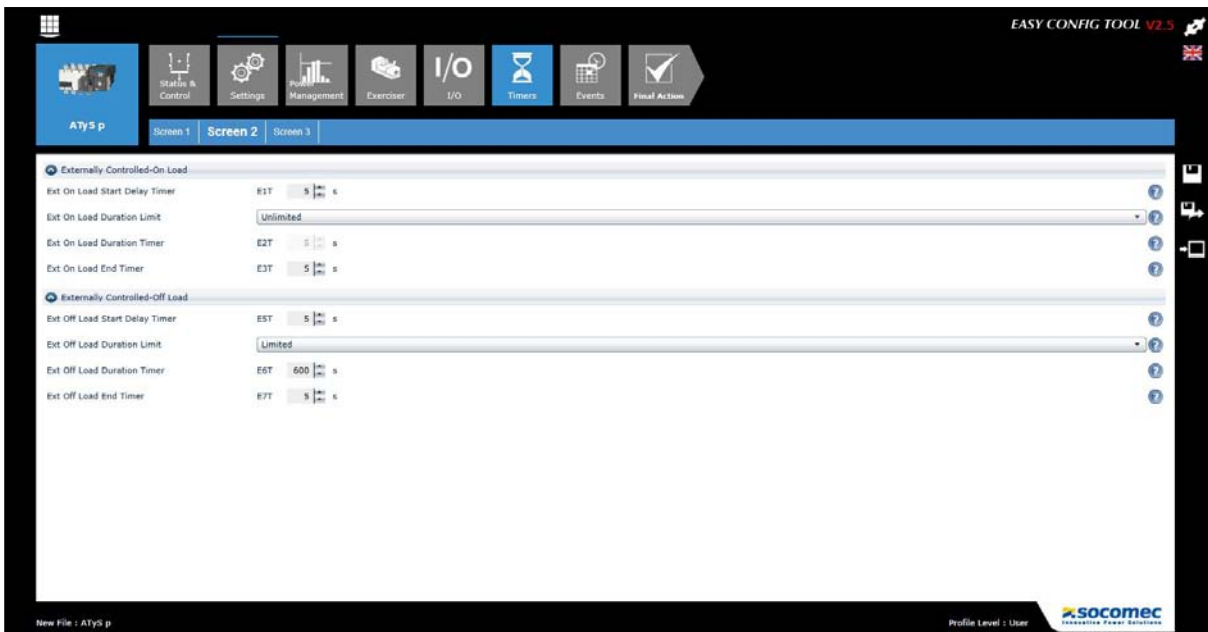

8.10. Timers screen 3

Same as with Timers screen 2, Timers screen 3 is applicable and only available for Main – Gen applications. When the “Type of Application” configuration under “Settings” is set to Main – Main, this screen will be hidden. It allows configuration of timers linked to on and off load tests, as well as values dedicated to the genset.

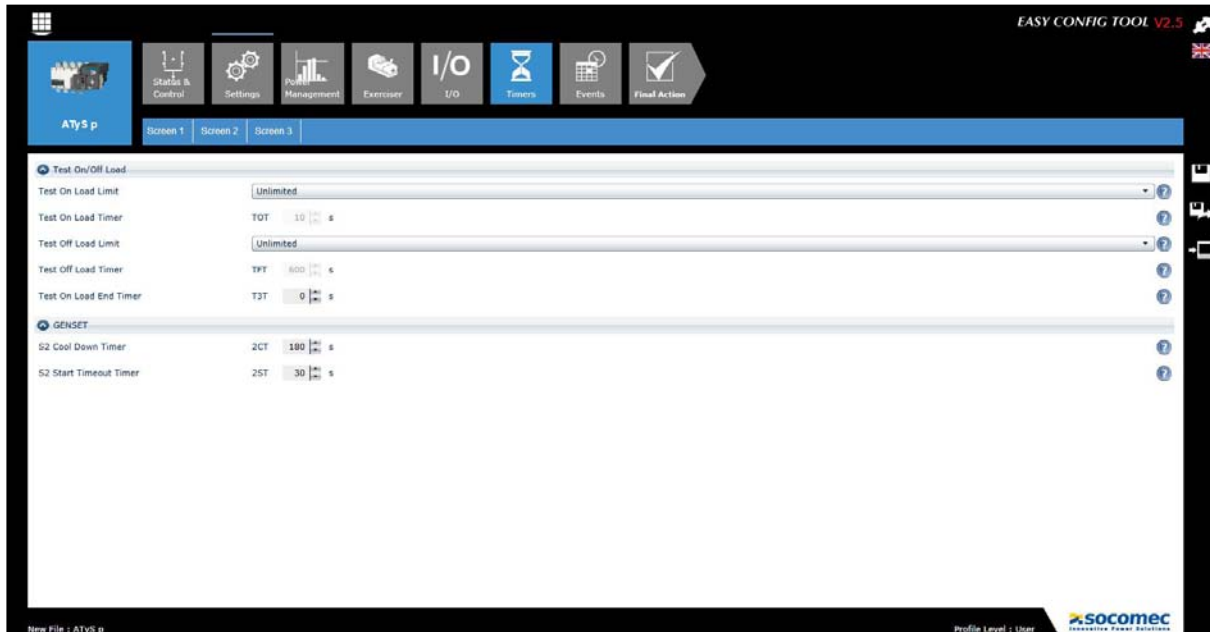

8.11. Event recording screen (only available for ATyS p)

The ATyS p includes an event recording data logger supported by a real time clock (RTC) that enables to record and timestamp an extensive series of events.

To view a series of events select the desired series from the list below and click view. A popup with the message “Getting Events” will appear during a few seconds until the data uploads.

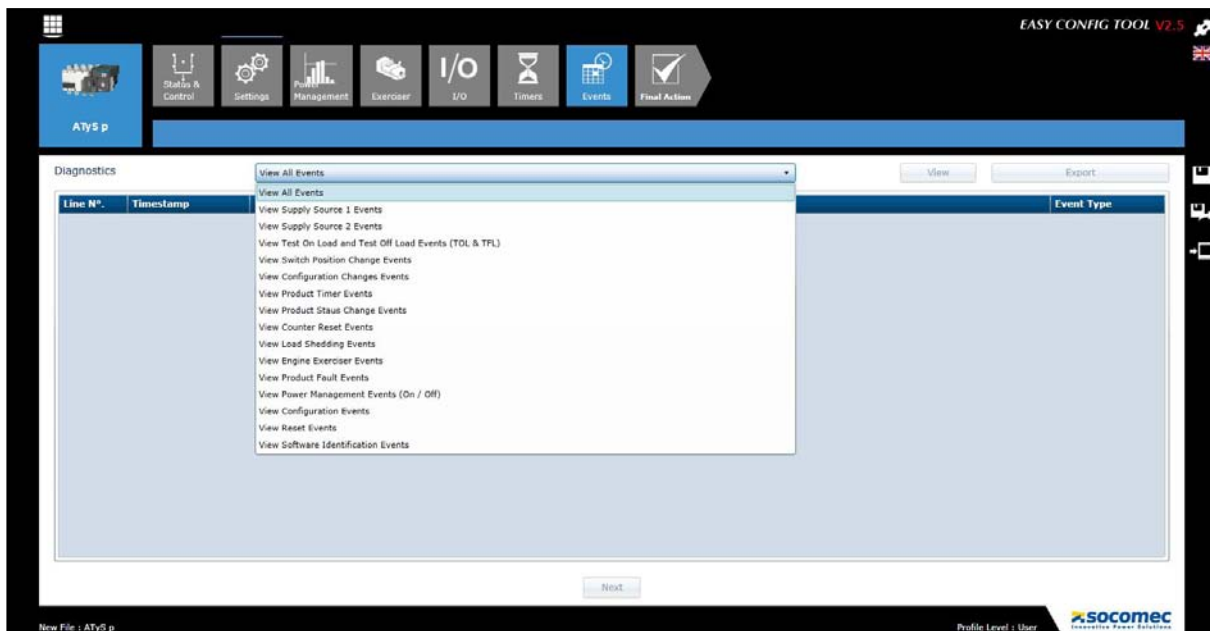

The software will upload the last 16 events with the latest displayed on top. (Line 1). Should you require to go further back into the history of events simply click on NEXT at the bottom of the screen. This will upload another 16 events that occurred prior to events already displayed. Events are all labeled with a Line number, a time and date stamp as well as the event details.

Once the required events have been uploaded it is possible to export the history of events viewed in CSV or converted to EXCEL format and customized as per user preference.

The ATyS p can store up to 3000 events on a FIFO (First In First Out) basis.

8.12. Super User added functionality

Easyconfig software includes added functionality such as Remote Control and Set/Reset functionality of the ATyS p. This functionality may be accessed by a Super User only.

8.12.1. Status and control screen

When connected as a Super User the Status Screen will include a «Control Panel» section at the bottom part. This section is dedicated to Remote Commands that allows the user to send orders to the transfer switch. For convenience, clarity and added safety, sending remote orders are confirmed by clicking on «Apply Buttons».

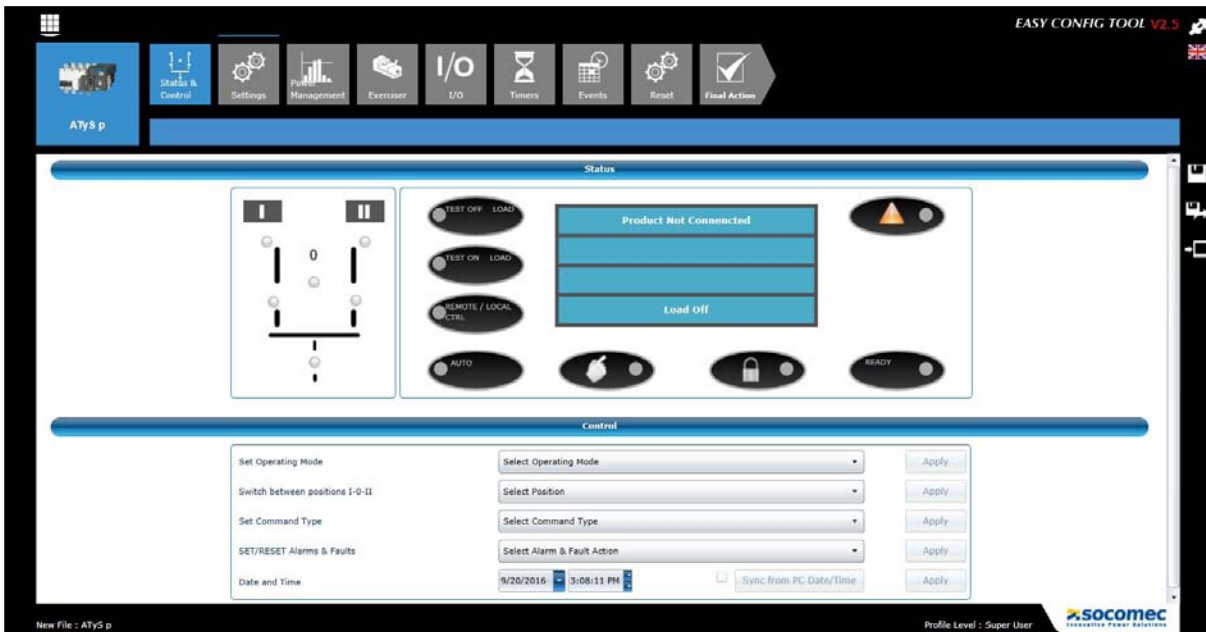

To initiate a specific operating mode select from the modes listed and click on Apply. A popup message will appear on the screen once the operation is successful. When selecting «Remote Control Mode», the «Remote / Local Ctrl» LED will light up and all other functions such as «Switch between positions I-O-II» become active.

This mode allows also to set and reset alarms and faults.

For ATyS p it also allows remote setting of the time and date, should they match those on the computer, one may click on the «Sync from PC Date/Time» button without setting the time manually. In both cases a popup message will appear on the screen once the operation is successful and the new dates and times set will be displayed.

8.12.2. Reste screen (only available for ATyS p)

When connected as a Super User a new screen becomes available. The user can can Reset various recorded data such as partial counters for both sources and genset counters.

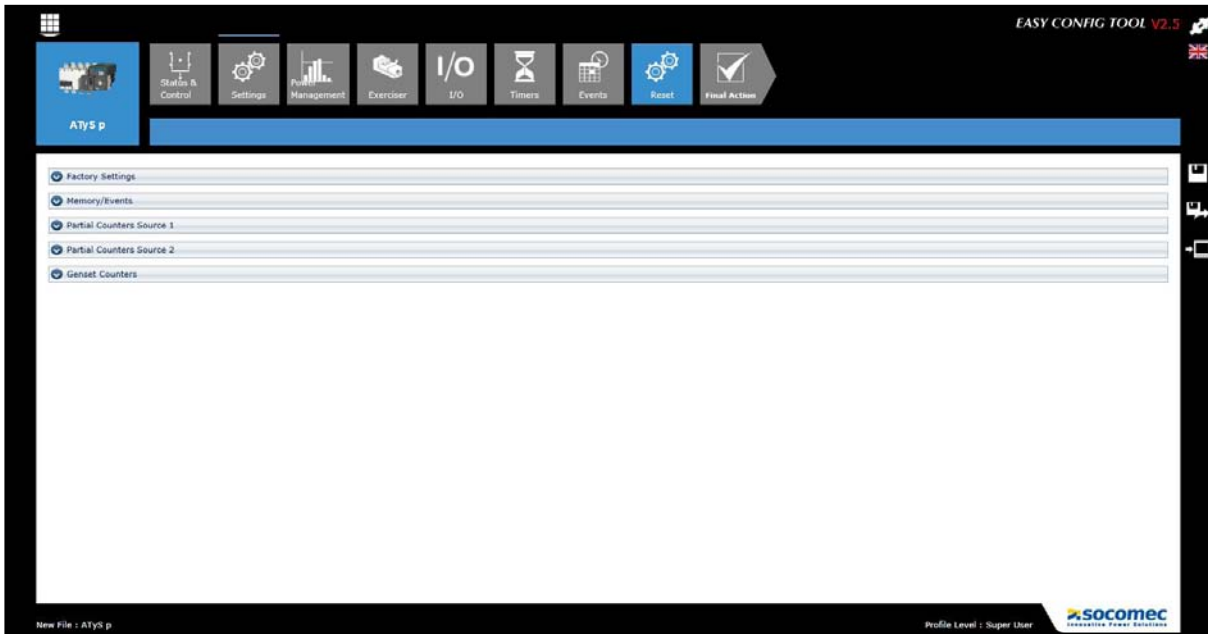

To reset a specific parameter click on the associated “RESET Button” adjacent to the data you want to reset. **Attn:** Once the reset command is confirmed, the data will be permanently deleted. A popup message will appear on the screen once the operation is successful.

To reset all settings in the product back to the factory default settings click on the Reset button in the Factory Settings section:

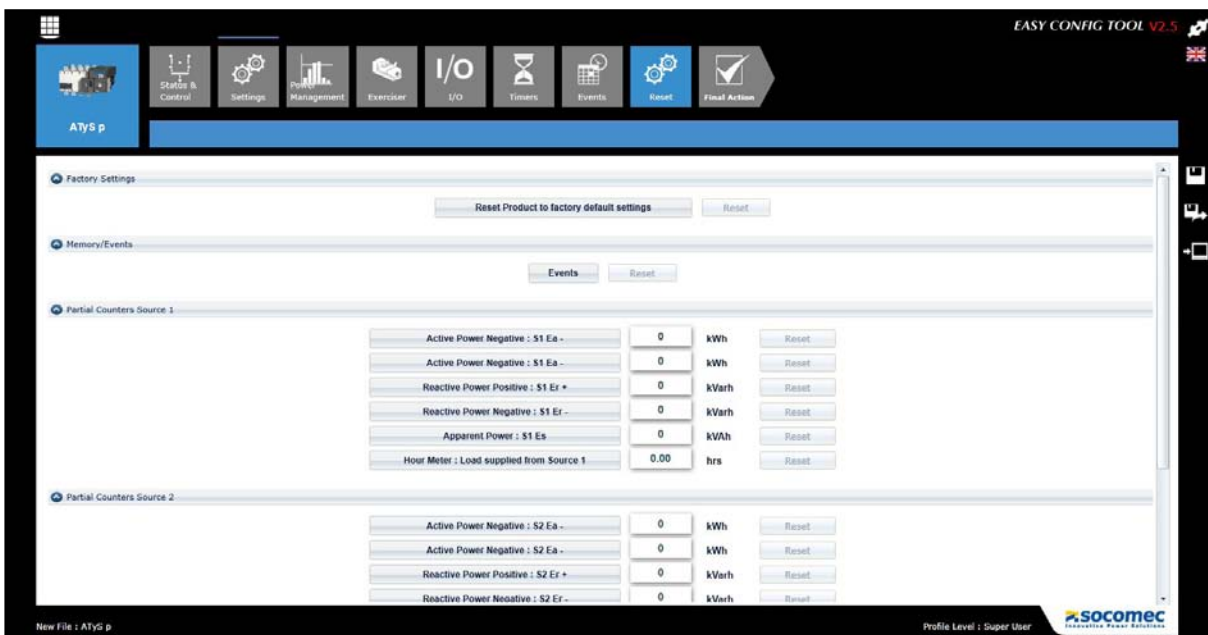

8.13. Final action

Once all the configurations have been completed for the selected device, the user has several options at his disposal:

- To record the configuration as a file
- To export it as a spreadsheet file in “.csv” format
- To send the configuration directly to the device for immediate application



Note: these actions can also be performed at any time, using the short-cuts on the right of the screen.



Send directly to the device for immediate application



Record as a file



Export as a spreadsheet file in ".csv" format

Incorrect configuration

If one or more steps of the configuration are incorrect they will be listed at the time of recording the configuration. They must be corrected to allow the configuration to be recorded.

The screenshot displays the EASY CONFIG TOOL V2.5 interface. At the top right, the title "EASY CONFIG TOOL V2.5" is visible. Below the title is a navigation bar with icons for Status & Control, Settings, Power Management, Exerciser, I/O, Timers, Events, Reset, and Final Action. The "Settings" icon is highlighted. Below the navigation bar is a blue header with the text "ATy5 p". The main area contains a table with the following data:

Error	Section Name	Error Level	Field
Value of nominal voltage should be between 208 and 277 or between 360 and 479 for selected network type	Settings - Screen 1	Error	Nominal Voltage
Under voltage thresholds value shall be between 98 to 98.	Settings - Screen 2 - Source 1	Error	Lower Voltage Limits

At the bottom left, it says "New File : ATy5 p". At the bottom right, it says "Profile Level : Super User" and the Socomec logo is present.

CORPORATE HQ CONTACT:
SOCOMECSAS
1-4 RUE DE WESTHOUSE
67235 BENFELD, FRANCE

www.socomec.com



543 118 C - EN - 10/16

 **socomec**
Innovative Power Solutions