

COUNTIS *E11/E12*

Single-phase energy meter
Direct - 80 A Pulse

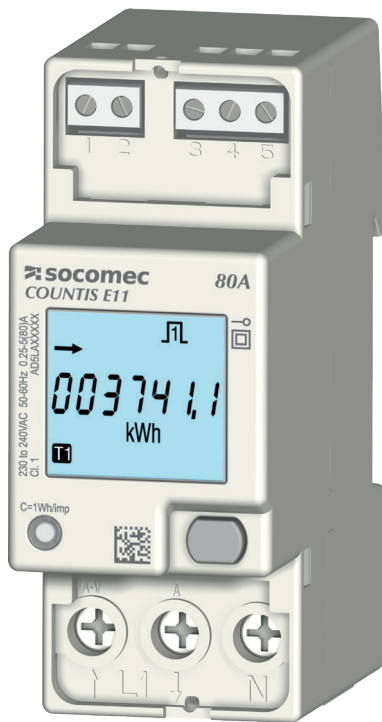

COUNTIS E11

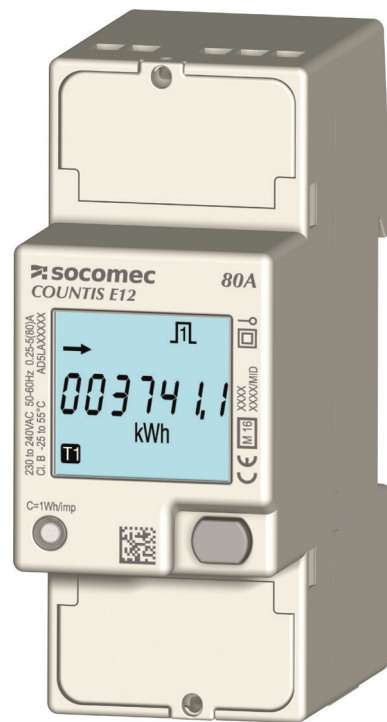

COUNTIS E12 - MID



1. DOCUMENTATION3
2. HAZARDS AND WARNINGS4
2.1. RISK OF ELECTROCUTION, BURNS OR EXPLOSION4
2.2. RISK OF DAMAGING THE UNIT4
2.3. RESPONSIBILITY4
3. PRELIMINARY OPERATIONS5
4. INTRODUCTION6
4.1. INTRODUCING THE COUNTIS E11 / E126
4.2. FUNCTIONS6
4.3. FRONT PANELS6
4.4. LCD DISPLAY7
4.5. DIMENSIONS7
4.6. ELECTRICAL READINGS8
5. INSTALLATION9
5.1. RECOMMENDATIONS AND SAFETY9
5.2. DIN RAIL MOUNTED9
6. CONNECTION10
6.1. CONNECTING THE COUNTIS E11/E1210
6.2. CONNECTION TO THE ELECTRICAL NETWORK AND TO THE LOADS10
7. MID COMPLIANCE11
8. CONFIGURATION12
8.1. ONSCREEN CONFIGURATION12
9. USE14
9.1. DETAILED VIEW OF THE TARIFF MENU, "TAR."15
9.2. DETAILED VIEW OF THE TOTAL MENU, "TOT"16
9.3. DETAILED VIEW OF THE MENU FOR PARTIAL AND REALTIME READINGS, "P. RT"17
9.4. DETAILED VIEW OF THE MENU "INFO"19
10. DIAGNOSTICS MESSAGES20
10.1. MALFUNCTION20
11. ASSISTANCE20
12. CHARACTERISTICS21
13. GLOSSARY OF ABBREVIATIONS23

1. DOCUMENTATION

All documentation on the COUNTIS E11/E12 is available online at:
www.socomec.com/en/countis-e1x



2. HAZARDS AND WARNINGS

The term "device" used in the paragraphs below refers to the COUNTIS E11/E12.

The assembly, use, servicing and maintenance of this equipment must only be carried out by trained, qualified professionals. SOCOMEC shall not be held responsible for failure to comply with the instructions in this manual.

2.1. Risk of electrocution, burns or explosion

- Only duly authorised and qualified personnel may work or install/uninstall the device.
- The instructions are valid together with the specific instructions for the device.
- The device is designed only for its intended purpose as set out in the instructions.
- Only accessories authorised or recommended by SOCOMEC may be used in association with the device.
- Before proceeding with installation, maintenance, cleaning, disassembly, connection, or maintenance work, the device and system must be cut off from the mains to avoid electrocution and damaging the system and device.
- This device is not designed to be repaired by the user.
- For any questions related to the disposal of the device, please contact SOCOMEC.

Failure to comply with the instructions of the device and this safety information can cause bodily injury, electric shock, burns, death or damage to property.

2.2. Risk of damaging the unit

To ensure that the unit operates correctly, make sure that:

- The unit is correctly installed.
- There is a maximum voltage at the voltage input terminals of 288 VAC phase-neutral
- The network frequency indicated on the device is observed: 50 or 60 Hz.
- There is a maximum current of 80 A at the current input terminals (I1).

Failure to respect these precautions could cause damage to the unit.

2.3. Responsibility

- Assembly, connection and use must be carried out in accordance with the installation standards currently in force.
- The unit must be installed in accordance with the rules given in this manual.
- Failure to observe the rules for installing this unit may compromise the device's intrinsic protection.
- The unit must be positioned within an installation which complies with the standards currently in force.
- Any cable which needs to be replaced may only be replaced with a cable having the correct rating.

3. PRELIMINARY OPERATIONS

To ensure the safety of staff and the equipment, it is vital to read and absorb the contents of these instructions thoroughly before commissioning.

Check the following points as soon as you receive the package containing the unit:

- The packaging is in good condition
- The unit has not been damaged during transportation
- The device reference number conforms to your order
- The package includes:
 - 1 device
 - 1 sealing kit (for COUNTIS E12)
 - 1 Quick Start guide

4. INTRODUCTION

4.1. Introducing the COUNTIS E11 / E12

The COUNTIS E11 and E12 are modular active and reactive electrical energy meters that display consumed energy. They are designed for single-phase networks and allow a direct connection of up to 80 A. They are equipped with two pulse outputs.

4.2. Functions

- Measures and displays total and partial energy
- Dual tariff management: T1 / T2
- Electrical parameter measurements: I, V, f
- Power, power factor
- Pulse output
- MID version (according to reference)

Description	Reference
COUNTIS E11	4850 3060
COUNTIS E12 - Version MID	4850 3061

4.3. Front panels

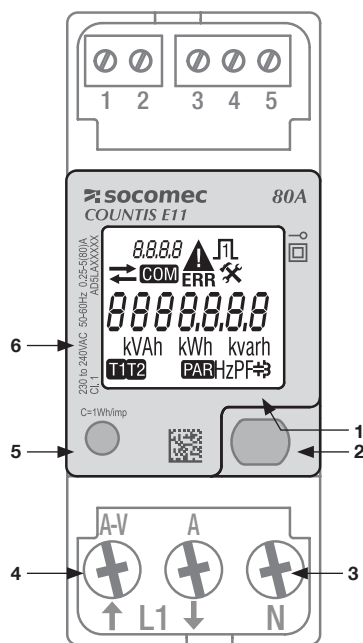
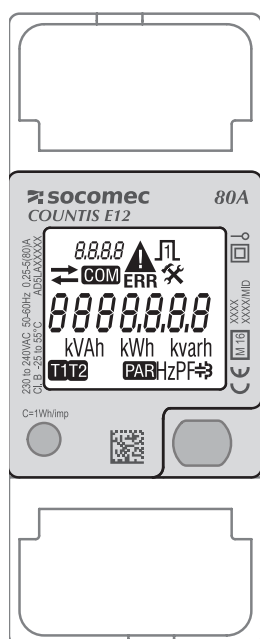

1. LCD display
2. ENTER key
3. Neutral connection
4. Single-phase network connection
5. Metrological LED
6. Information relating to MID certification

4.4. LCD display

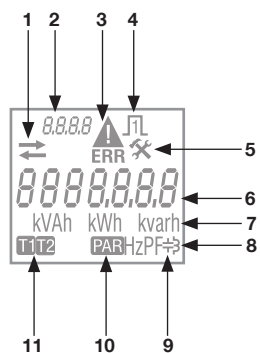

1. Imported (→) or exported (←) energy or power
2. Identification of current menu
3. Device malfunction. Replace the device
4. Active pulse output
5. Setup menu
6. Main zone
7. Unit of measure
8. Inductive value
9. Capacitive value
10. Partial meters. Flashing = partial meter has stopped
11. Tariff display

4.5. Dimensions

Dimensions: in/mm

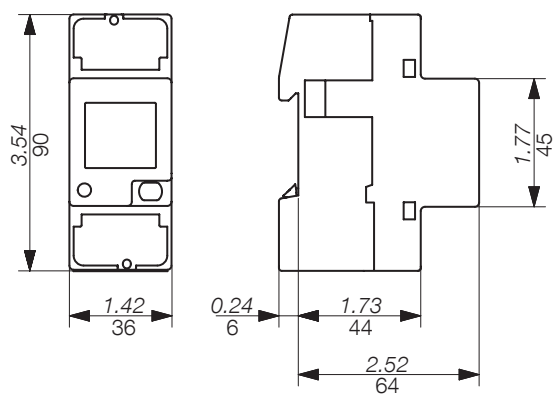

4.6. Electrical readings

4.6.1. Measurements

Settings vary by model.

REALTIME VALUES	SYMBOL	UNIT OF MEASURE	LCD DISPLAY
Neutral voltage	V	V	●
Current	I	A	●
Power factor	PF		●
Active power	P	kW	●
Reactive power	Q	kvar	●
Frequency	f	Hz	●
Direction of current	↻		●
Logged data			
Total active, reactive and apparent energy	Ea, Er, Eap	kWh, kvarh, kVAh	●
Total reactive, inductive and capacitive energy	Er	kvarh	●
Total active and reactive energy for each tariff (T1/T2)	Ea, Er	kWh, kvarh	●
Active, partial energy for each tariff (T1/T2)	Ea	kWh	●
Partial active and reactive energy	Ea, Er	kWh, kvarh	●
Miscellaneous			
Current tariff	T	1/2	●
Partial meters	PAR	START/STOP	●
State of the pulse output	⏏	Active / inactive	●

5. INSTALLATION

The paragraphs below describe how to install the device.

5.1. Recommendations and safety

Refer to the safety instructions (section "2. Hazards and warnings", page 4)

- Keep away from electromagnetic interference generator systems,
- Avoid vibrations with accelerations greater than 1 g for frequencies lower than 60 Hz.

5.2. DIN rail mounted

The COUNTIS E11/E12 can be mounted on a 35-mm DIN rail (EN 60715TM35). They must be used inside electrical cabinets.

6. CONNECTION

6.1. Connecting the COUNTIS E11/E12

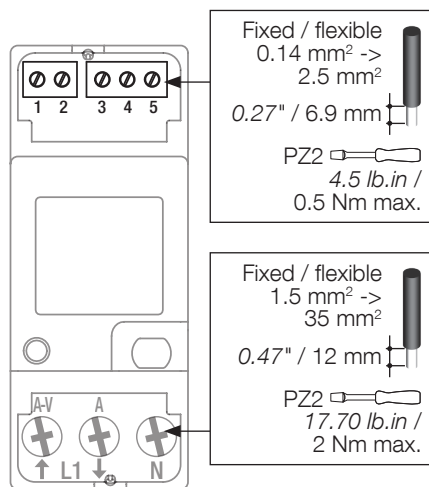

6.2. Connection to the electrical network and to the loads

The COUNTIS E11/E12 are intended for single-phase networks with neutral.

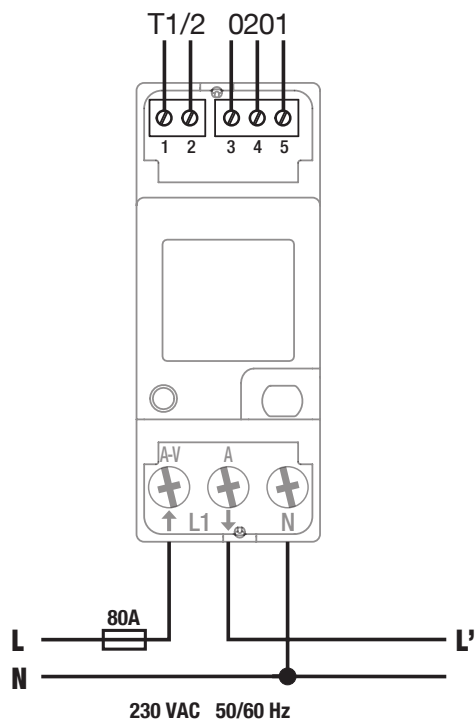

Tariff input

1-2: Switch tariffs:
0 VAC/DC -> Tariff 1
80-276 VAC/DC -> Tariff 2

Pulse output 1

4-5: Ea+

Pulse output 2

3-4: Er+
Optoisolated pulse outputs - up to 250VAC/DC 100mA
acc. to EN62053-31

Network

L1 A-V: Phase input
L': A: Phase output
N: Neutral connection

7. MID COMPLIANCE

The following points must be taken into consideration to ensure that the device is used in compliance with directive MID 2014/32/EU:

- **Type of network**

COUNTIS E12 meters comply with the MID directive for connection to networks: 1P+N (see "6.2. Connection to the electrical network and to the loads", page 10)

- **Fitting terminal covers**

After connecting the device, ensure that the terminal covers are fitted properly and secured by the plastic seals provided with the device.

- **MID Declaration of Conformity**

The MID Declaration of Conformity is available on the website: www.socomec.com/en/countis-e1x

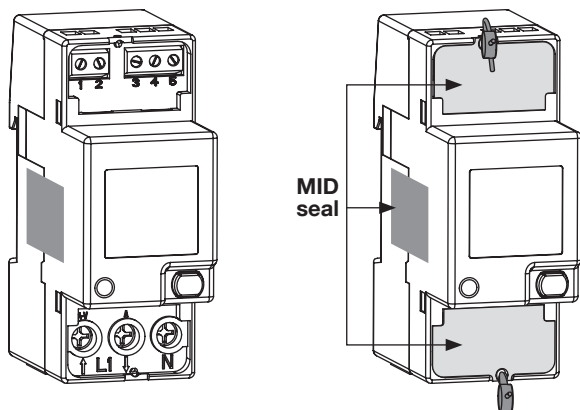

8. CONFIGURATION

The device can be configured directly from the COUNTIS E11/E12 screen in programming mode. The paragraphs below describe configuring using the screen.

8.1. Onscreen configuration

From the screen, go to programming mode to reset partial energy to zero. How to browse through the programming mode is described in the following stages:

Function	Where	Buttons	Press
Switch menus	Every page except SETUP menu		Double speed (x2 < 0.5 sec)
Switch pages within a menu	Every page within a menu		Realtime
Go to SETUP menu	Menu page SETUP		> 3 sec
Exit SETUP menu	SETUP Menu		> 3 sec
Start/stop the displayed partial meter	Partial meter menu		> 3 sec
Reset the displayed partial meter to zero	Partial meter menu		> 3 sec
Display test	Every page with the exception of SETUP and partial meters		> 10 sec

8.1.1. View all of the menu "SETUP"

In the SETUP menu, press " " for 3 seconds to put the device into programming mode.

Press " " to go to the different screens:

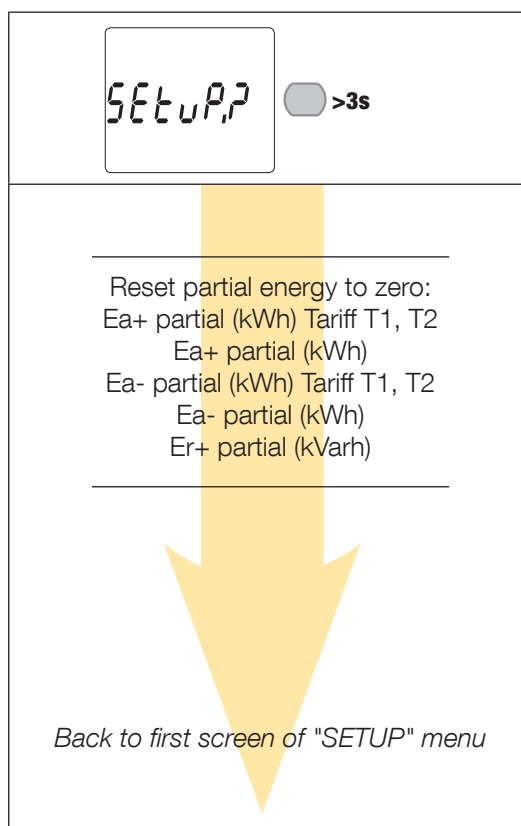

8.1.2. Detailed view of menu "SETUP"



Reset energy	
<p>SEt</p> <p>RES ALL</p> <p>PAR</p>	<p>Ea+ partial Tariff T1, T2; Ea+ partial; Ea- partial Tariff T1, T2; Ea- partial; Er+ partial</p>

Back to first screen of "SETUP" menu

9. USE

Switch menus by pressing " " twice for at least 0.5 seconds.
Press " " to see the electrical readings or menu information.

The menus and related measurements are described in the table below:

Tariff (Tar.)	Total (tot)	Partial and realtime readings (P. rt)	Information (inFo)
<p>Tariff 1 - Imported and exported active energy</p> <hr/> <p>Tariff 1 - Imported and exported reactive energy</p> <hr/> <p>Tariff 2 - Imported and exported active energy</p> <hr/> <p>Tariff 2 - Imported and exported reactive energy</p> <hr/> <p><i>Back to first screen of "Tar." menu</i></p>	<p>Total imported and exported active energy</p> <hr/> <p>Total apparent energy</p> <hr/> <p>Total imported and exported inductive reactive energy</p> <hr/> <p>Total imported and exported capacitive reactive energy</p> <hr/> <p>Total imported and exported reactive energy</p> <hr/> <p><i>Back to first screen of "tot" menu</i></p>	<p>Partial imported active energy by tariff</p> <hr/> <p>Partial imported active energy</p> <hr/> <p>Partial exported active energy by tariff</p> <hr/> <p>Partial exported active energy</p> <hr/> <p>Partial imported reactive energy</p> <hr/> <p>Active and reactive power</p> <hr/> <p>Voltage</p> <hr/> <p>Current</p> <hr/> <p>Power factor</p> <hr/> <p>Frequency</p> <hr/> <p><i>Back to first screen of "P.rt" menu</i></p>	<p>Metrological firmware version</p> <hr/> <p>Non-metrological firmware version</p> <hr/> <p>Checksum of metrological firmware</p> <hr/> <p>Checksum of non-metrological firmware</p> <hr/> <p><i>Back to first screen of "InFO" menu</i></p>

9.1. Detailed view of the tariff menu, "Tar."

Imported active energy, tariff 1	
t_{Ar} → 000062.2 kWh	

Exported active energy, tariff 1	
t_{Ar} ← 000062.2 kWh	

Imported reactive energy, tariff 1	
t_{Ar} → 000062.2 kvarh	

Exported reactive energy, tariff 1	
t_{Ar} ← 000062.2 kvarh	

Imported active energy, tariff 2	
t_{Ar} → 000062.2 kWh	

Exported active energy, tariff 2	
t_{Ar} ← 000062.2 kWh	

Imported reactive energy, tariff 2	
t_{Ar} → 000062.2 kvarh	

Exported reactive energy, tariff 2	
t_{Ar} ← 000062.2 kvarh	

Back to first screen of "Tar." menu

9.2. Detailed view of the total menu, "tot"

Total imported active energy	
$\xrightarrow{\text{tot}}$ 000083.2 kWh	

Total exported active energy	
$\xleftarrow{\text{tot}}$ 000083.2 kWh	

Total apparent energy	
tot 000083.2 kVAh	

Total imported inductive reactive energy	
$\xrightarrow{\text{tot}}$ 000083.2 kvarh ⤵	

Total exported inductive reactive energy	
$\xleftarrow{\text{tot}}$ 000083.2 kvarh ⤵	

Total imported capacitive reactive energy	
$\xrightarrow{\text{tot}}$ 000083.2 kvarh ⚡	

Total exported capacitive reactive energy	
$\xleftarrow{\text{tot}}$ 000083.2 kvarh ⚡	

Total imported reactive energy	
$\xrightarrow{\text{tot}}$ 000083.2 kvarh	

Total exported reactive energy	
$\xleftarrow{\text{tot}}$ 000083.2 kvarh	

Back to first screen of "tot" menu

9.3. Detailed view of the menu for partial and realtime readings, "P. rt"

Imported partial active energy for tariff T1	
$\xrightarrow{P, rt}$ 000083.2 kWh T1 PAR	
Imported partial active energy for tariff T2	
$\xrightarrow{P, rt}$ 000083.2 kWh T2 PAR	
Partial imported active energy	
$\xrightarrow{P, rt}$ 000083.2 kWh PAR	
Exported partial active energy for tariff T1	
$\xleftarrow{P, rt}$ 000083.2 kWh T1 PAR	
Exported partial active energy for tariff T2	
$\xleftarrow{P, rt}$ 000083.2 kWh T2 PAR	
Partial exported active energy	
$\xleftarrow{P, rt}$ 000083.2 kWh PAR	
Partial imported reactive energy	
$\xrightarrow{P, rt}$ 000083.2 kvarh PAR	

Realtime active power	
$\xrightarrow{P, rt}$ 08.32 kW	
Realtime reactive power	
$\xrightarrow{P, rt}$ 08.32 kvar ±	
Realtime voltage	
P, rt 228.2 V	
Realtime current	
P, rt 00.00 A	
Realtime power factor	
P, rt 0.000 PF±	
Frequency	
P, rt 50.01 Hz	

Back to first screen of "P. rt" menu

9.3.1. Starting up the partial energy meter

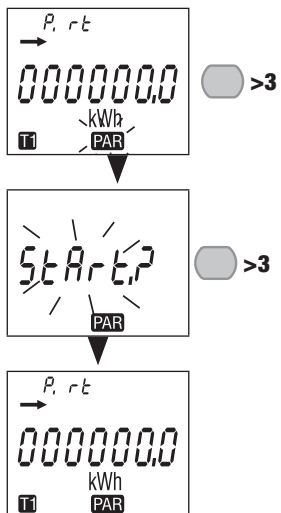

9.3.2. Stopping the partial energy meter

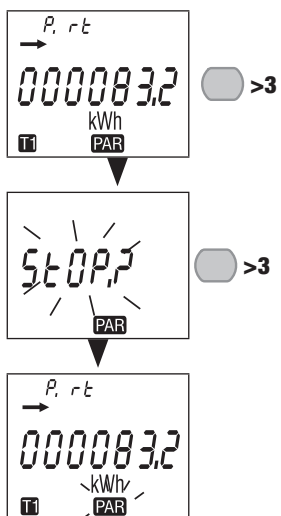

9.3.3. Resetting the partial energy meter to zero

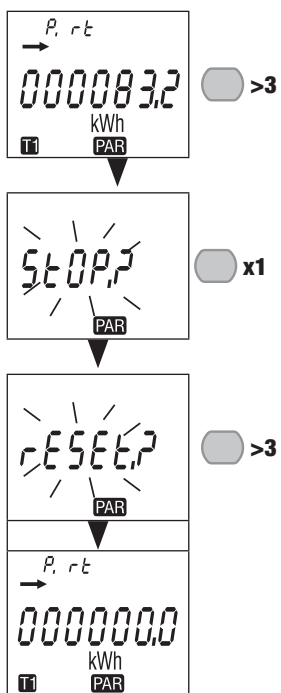

9.4. Detailed view of the menu "info"

Metrological firmware version	
<i>Info</i>	
Fr 1 1.22	

Non-metrological firmware version	
<i>Info</i>	
Fr 2 3.00	

Checksum of metrological firmware	
<i>Info</i>	
C5 1C 166	

Checksum of non-metrological firmware	
<i>Info</i>	
C52587E	



Back to first screen of "info" menu

10. DIAGNOSTICS MESSAGES

The following message appears if there are connection or malfunction errors.

10.1. Malfunction



- If you see this message, the meter has malfunctioned and must be replaced.

11. ASSISTANCE

Causes	Solutions
Device not working	Check the neutral and phase 1 cable connections
Error message	Check the meter is working OK

12. CHARACTERISTICS

GENERAL FEATURES	
Compliant with	European EMC Directive No. 2014/30/EU dated 26/02/2014 LV Directive No. 2014/35/EU dated 26/02/2014 Measuring Instrument Directive MID No. 2014/32/EU dated 26/02/2014 EN50470-1/-3 IEC 62053-21/-23
Frequency	45 and 65 Hz
Power supply	Self-supplied
Rated dissipated power (Wmax.)	7.5VA - 0.5W
FEATURES	
Single-phase connectivity	2 wires 230 - 400V
Stores energy readings and settings	In FRAM memory
Identifies display of tariffs	T1 and T2
CURRENT MEASUREMENTS	
Type	Single-phase - direct 80 A
Input consumption	0.5VA
Startup current (Ist)	20mA
Minimum current (Imin)	0.25A
Transition current (Itr)	0.5A
Reference current (Iref)	5A
Permanent overload (Imax)	80A
Intermittent overload	30 Imax for 1/2 cycle
OVERLOAD CAPACITY	
Continuous voltage Un	276 VAC
Realtime voltage Un (1 s)	300 VAC
Continuous current Imax	80 A
Realtime current Imax	30 Imax for 1/2 cycle
VOLTAGE MEASUREMENTS	
Range of measurement	230-240V ± 20%
Consumption	7.5VA max
Permanent overload	290V phase-neutral
FREQUENCY MEASUREMENT	
Frequency measurement	45-65 Hz
ENERGY MEASUREMENT	
Active	Yes
Reactive	Yes
Total and partial reading	Yes
MID metering	Bidirectional with single-phase
Resolution	10 Wh, 10 varh
ENERGY ACCURACY	
Active energy Ea+	Class B (EN 50470-3) E12 Class 1 (EN 62053-21)
Reactive energy Er+	Class 2 (EN 62053-23)

TARIFF for Ea+	
Tariff management	Yes (via Tariff input)
Number of tariffs managed	2
Tariff input	Yes
METROLOGICAL LED (Ea+)	
Pulse value	1000 pulses / kWh
Colour	Red
PULSE OUTPUT	
Type	Opto-isolated - 5 ... 27VDC 27mA according to EN 62053-31
Pulse weight	100 Wh/varh
O1	Ea+
O2	Er+
DISPLAY	
Type	7-digit LCD with backlight
Refresh time	1 s
Backlight activation time	10 s
Active energy: 1 display, 7-digit	000000.0 - 999999.9 kWh
Reactive energy: 1 display, 7-digit	000000.0 - 999999.9 kvarh
Apparent energy: 1 display, 7-digit	000000.0 - 999999.9 kVAh
Realtime active power: 1 display, 4-digit	00.00 - 99.99 kW
Realtime reactive power: 1 display, 4-digit	00.00 - 99.99 kvar
Realtime voltage: 1 display, 4-digit	000.0 ... 999.9 V
Realtime current: 1 display, 4-digit	00.00 ... 99.99 A
Power factor: 1 display, 4-digit	0.001-1.000
Frequency: 1 display, 4-digit	45.00-65.00 Hz
SAVING	
Energy registers	In FRAM memory
ENVIRONMENTAL CONDITIONS	
Mechanical environment	M1
Electromagnetic environment	E2
Operating temperature range	-25°C to +55°C
Storage temperature	-25°C to +75°C
Humidity	≤ 80%
Installation	Internal (box/cabinet)
Vibrations	±0.075 mm
HOUSING	
Dimensions W x H x D (mm)	Modular - width of 2 modules (DIN 43880) 36 x 90 x 64
Installation	On DIN rail (EN 60715)
Connection capacity, tightening torque	See chapter "6. Connection", page 10
Protection index	Front: IP51 - casing: IP20
Insulation class	Class II (EN 50470-1)
Weight	215 g

13. GLOSSARY OF ABBREVIATIONS

info	Menu information
Fr1	Metrological firmware version
Fr2	Non-metrological firmware version
CS1.	Checksum of metrological firmware
CS2.	Checksum of non-metrological firmware
tAr.	Tariff menu
tot	Total menu
P. rt	Partial and realtime readings menu
SEtuP.	Setup menu
rESALL	Reset all partial energies
SAVE?	Confirm selection
Y	Save and exit
N	Exit without saving
C	Continue without saving

CORPORATE HQ CONTACT:
SOCOMECSAS
1-4 RUE DE WESTHOUSE
67235 BENFELD, FRANCE

www.socomec.com

