

STEP 1 / 第1步

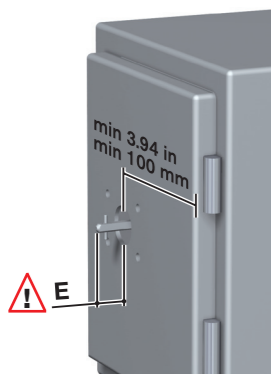

STEP 2 / 第2步

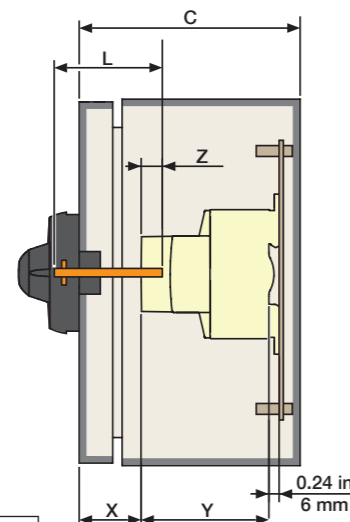

\* Possible assembly with two screws  
Montage avec 2 vis possible  
可用2个螺丝安装

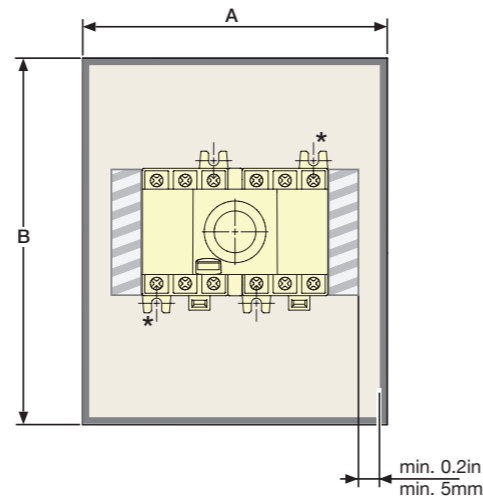

	L	min./最小	max./最大
Type S000	L = X + 0.98 in L = X + 25 mm	0.31 in / 8 mm	0.39 in / 10 mm
Type S00	L = X + 1.18 in L = X + 30 mm	0.51 in / 13 mm	0.59 in / 15 mm
Type S01	L = X + 1.43 in L = X + 36.5 mm	0.68 in / 17,5 mm	0.84 in / 21,5 mm

Dual dimensions in/mm  
Double dimensions in/mm  
Doble dimensiones in/mm  
双单位尺寸

Add. Pole  
Pôle additionnel  
Polo adicional  
附加极



Aux. Contacts  
Contacts aux.  
Contactos auxiliares  
辅助触点

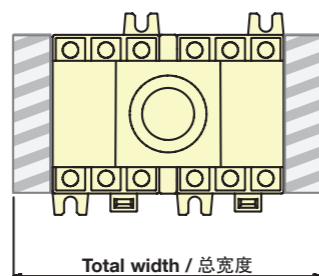
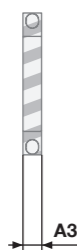

Total width / 总宽度 =  
A1 + x A2 + y A3

if/如果 x = 0 y = 4 max/最大  
if/如果 x = 1 y = 3 max/最大  
if/如果 x = 2 y = 2 max/最大

Switch / Interrupteur / Interruptor

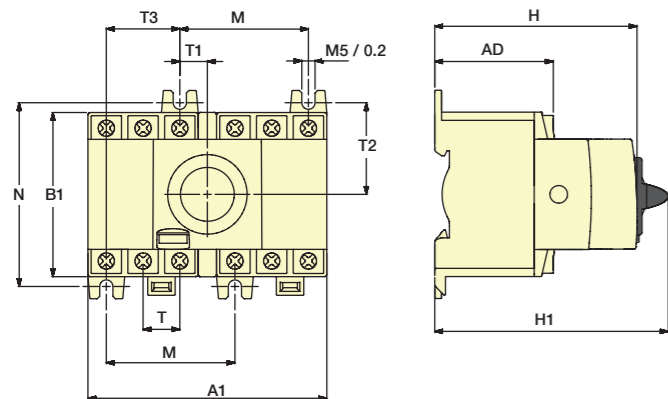

	M16 to/到 M40 - M CD63		M63 - M80 - M CD100	
	in	mm	in	mm
A	5.51	140	6.69	170
A1	3.83	97.5	4.13	105
A2	0.59	15	0.68	17,5
A3	0.34	8,8	0.34	8,8
AD	1.90	48,5	1.90	48,5
B	5.78	147	7.83	199
B1	2.67	68	3	76
C	4.33	110	4.33	110
H	3.30	84	3.30	84
H1	3.74	95	3.74	95
N	2.95	75	3.35	85
M	2.06	52,5	2.06	52,5
T	0.59	15	0.68	17,5
T1	0.44	11,25	0.34	8,75
T2	1.47	37,5	1.67	42,5
T3	1.18	30	1.38	35
Z min.	0.39	10	0.39	10
Z max.	0.59	15	0.59	15

KIT CHANGEOVER SWITCH/转换开关功能组件  
M 16 - M 20 - M 25 - M 32 - M 40 - M CD63  
KIT CHANGEOVER SWITCH/转换开关功能组件  
M 63 - M 80 - M CD100

GB Instruction sheet E Instrucciones de servicio  
F Notice d'utilisation CN 说明书



Kit for CHANGEOVER SWITCH I - I+II - II  
转换开关I-I+II-II功能组件

22996009

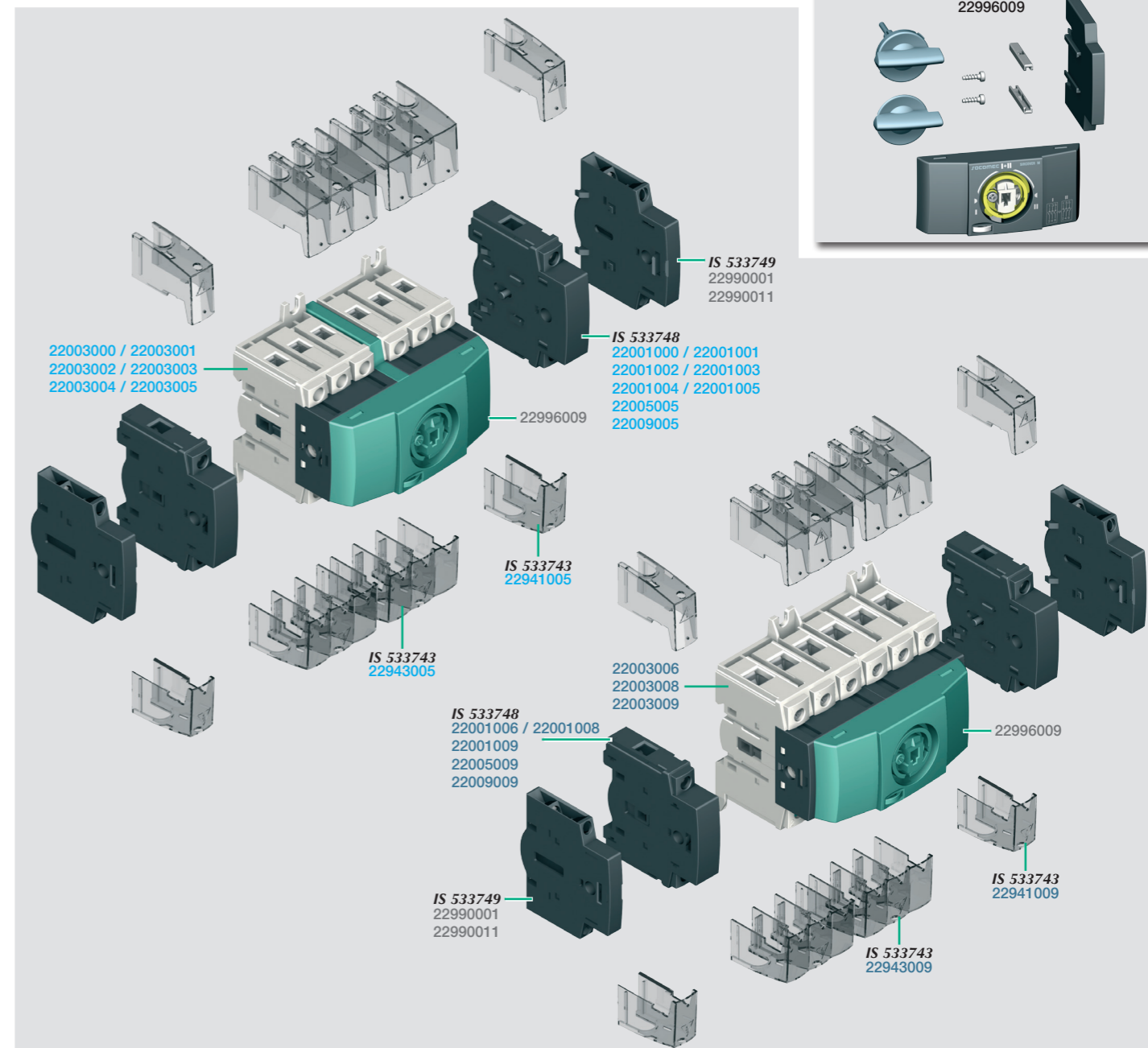
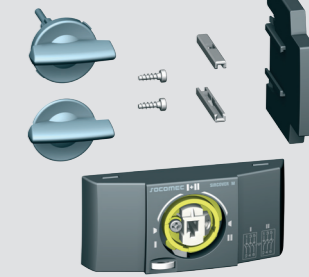

Edition 05/14 - IS 533753- G / RECTO-VERSO / S blanc offset quadri 80g/m²

M16 to/到 M40 - M CD63		M63 - M80 - M CD100	
Wire / Câble / Cable / 电缆	Torque / Couple / Par de apriete / 扭矩	Wire / Câble / Cable / 电缆	Torque / Couple / Par de apriete / 扭矩
1,5 mm <sup>2</sup> - 16 mm <sup>2</sup> 14 - 4 AWG stranded 14 - 10 AWG solid 2x14 - 2x12 AWG stranded 2x12 AWG solid	26.5 lb.in / 3 Nm	2,5 mm <sup>2</sup> - 35 mm <sup>2</sup> 14 - 1 AWG stranded 14 - 10 AWG solid 2x10 - 2x6 AWG stranded 2x12 AWG solid	39.8 lb.in / 4.5 Nm

Use copper conductors only, 75°C or higher.  
只能使用铜缆 75°C或更高  
Flat 6,5 / 一字螺丝刀  
Pozidriv 2 / 十字螺丝刀  
0.35 in / 9 mm (M16 to/到 M40 - M CD63)  
0.47 in / 12 mm (M63 to/到 M100 - M CD100)  
Stripping distance / 绝缘剥离长度

WARNING / ATTENTION / PRECAUCIÓN / 注意

The opening of the branch-circuit protective device may be an indication that a fault has been interrupted. To reduce the risk of fire or electric shock, current-carrying parts and other components of the controller should be examined and replaced if damaged.

La activación del dispositivo de protección frente a derivaciones puede significar que se ha interrumpido una corriente de fallo. Para reducir el riesgo de incendio o de choque eléctrico, las piezas portadoras de corriente y demás componentes del pedido deberán comprobarse y sustituirse en caso de que se encuentren dañados.

Le déclenchement du dispositif de protection des dérivations peut signifier qu'un courant de défaut a été interrompu. Pour réduire le risque d'incendie ou de choc électrique, les pièces porteuses de courant et les autres composants de la commande doivent être vérifiées et remplacés s'ils sont endommagés.

支路保护装置动作表示一个故障电流已经被中断。为了减少火灾或触电的危险，通电流部分和其它控制部件应进行检查。如有损坏，必须更换。

DANGER / PELIGRO / 危险

**HAZARDOUS VOLTAGE.** This equipment must be installed and serviced only by qualified electrical personnel. Turn off all power supplying this equipment before working on or inside equipment. Always use a properly rated voltage sensing device to confirm power is off. Replace all devices, doors, and covers before turning on power to this equipment. Failure to follow these instructions will result in death or serious injury.

**TENSION PELIGROSA.** Solamente el personal de mantenimiento eléctrico especializado deberá instalar y prestar servicios de mantenimiento a este equipo. Desenergice el equipo antes de realizar cualquier trabajo en él. Siempre utilice un dispositivo detector de tensión adecuado para confirmar la desenergización del equipo. Vuelva a colocar todos los dispositivos, las puertas y las cubiertas antes de energizar este equipo. El incumplimiento de estas precauciones podrá causar la muerte o lesiones serias.

**TENSION DANGEREUSE.** L'installation et l'entretien de cet appareil ne doivent être effectués que par du personnel qualifié. Coupez l'alimentation de cet appareil avant d'y travailler. Utilisez toujours un dispositif de détection de tension à valeur nominale approprié pour confirmer que toute alimentation est coupée. Remplacez tous les dispositifs, les portes et les couvercles avant de mettre cet appareil sous tension. Si ces précautions ne sont pas respectées, cela entraînera la mort ou des blessures graves.

危险电压。这类装置必须由专业人员进行安装和维修。在电气装置上或内部进行操作前必须关掉所有外电源。使用合适的额定电压测量装置来确认电源已经关掉。在电气装置送电前必须重新放好所有的部件。柜门和开关盖。不遵守以上预警将导致严重伤害或死亡。

Mounting kit for CHANGEOVER SWITCH I - I+II - II M 16 to M 40 - M CD63  
M16-M40-M CD63的转换开关I-I+II-II组件安装

**STEP 1 / 第1步**

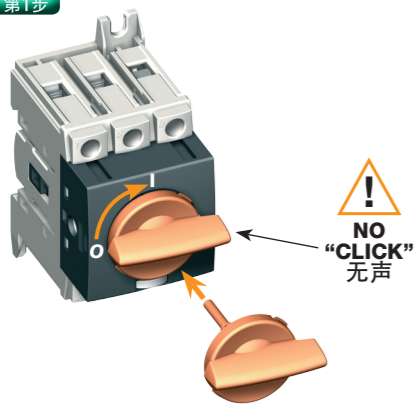

**STEP 2 / 第2步**

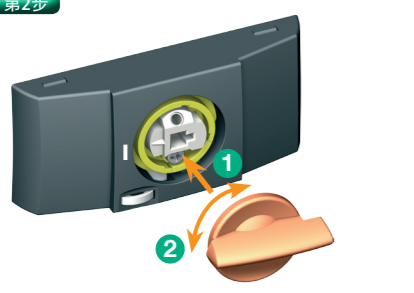

**STEP 3 / 第3步**

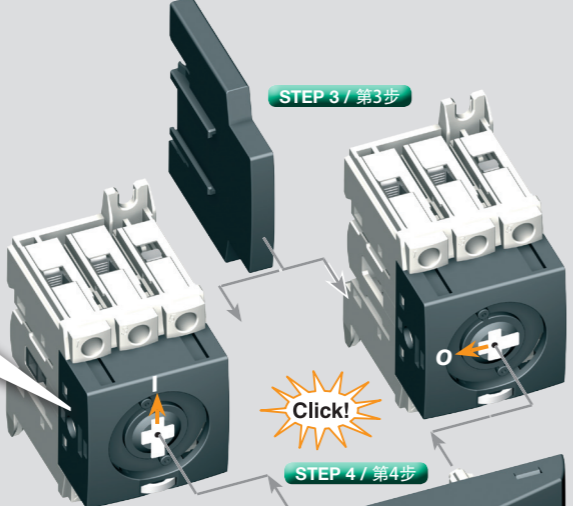

**STEP 4 / 第4步**



DIRECT OPERATION  
直接操作

**STEP 5 END**

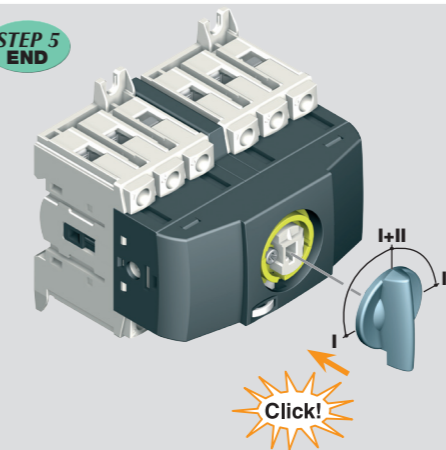

FRONT  
EXTERNAL  
OPERATION  
柜外正面操作

**STEP 5 / 第5步**

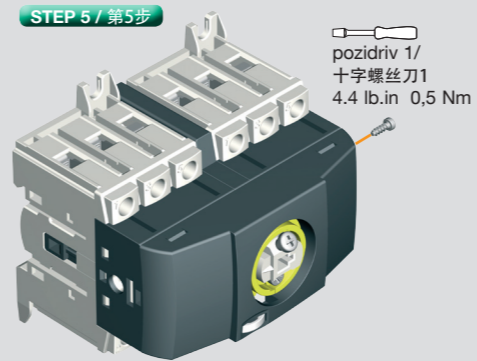

pozidriv 1 / 十字螺丝刀1  
4.4 lb.in 0,5 Nm

**STEP 6 / 第6步**

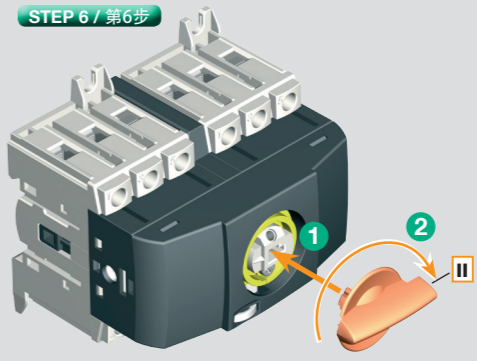

**STEP 7 / 第7步**

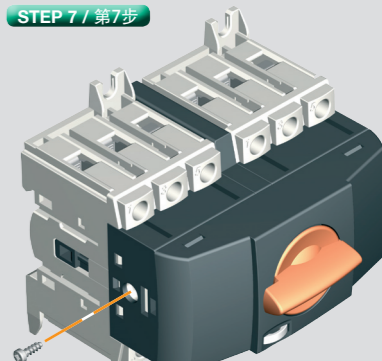

pozidriv 1 / 十字螺丝刀1  
4.4 lb.in 0,5 Nm

Mounting switch for CHANGEOVER SWITCH I - I+II - II M 63 - M 80 - M CD100  
M63-M80-M CD100的转换开关I-I+II-II组件安装

**STEP 1 / 第1步**

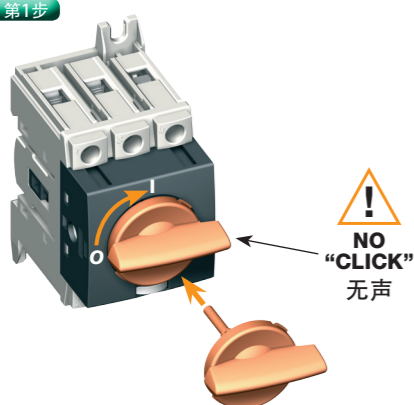

**STEP 2 / 第2步**

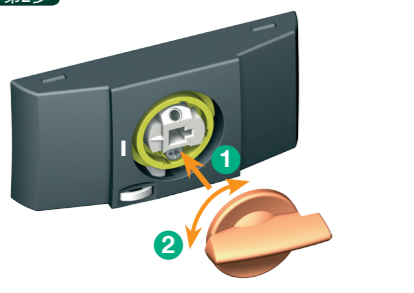

**STEP 3 / 第3步**

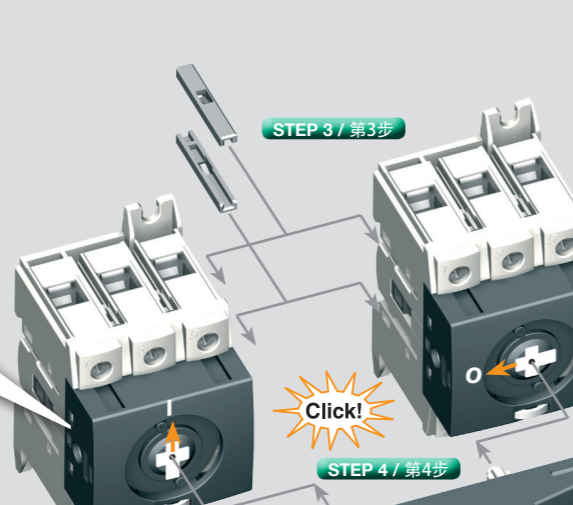

**STEP 4 / 第4步**

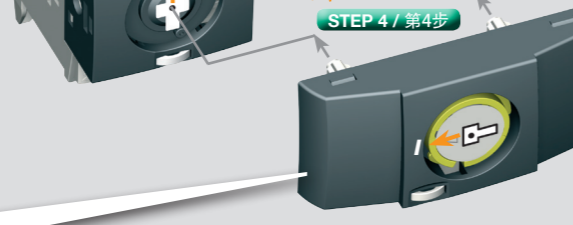

**STEP 9 / 第9步**  
**END / 最后一步**

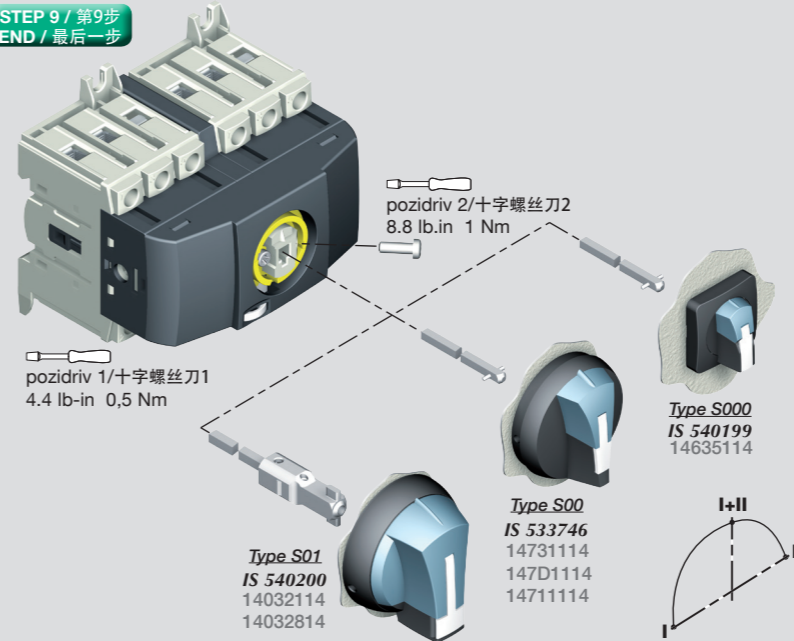

pozidriv 2 / 十字螺丝刀2  
8.8 lb.in 1 Nm

pozidriv 1 / 十字螺丝刀1  
4.4 lb.in 0,5 Nm

Type S01  
IS 540200  
14032114  
14032814

Type S00  
IS 533746  
14731114  
147D1114  
14711114

Type S000  
IS 540199  
14635114

**STEP 8 / 第8步**

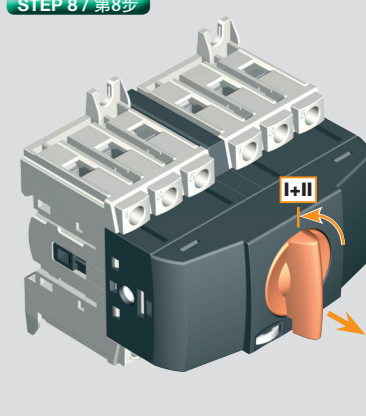

**CONFIGURATION**  
安装方式

**STEP 2 / 第2步**



max. Ø 0.19 in / Ø 5 mm  
min. Ø 0.15 in / Ø 4 mm  
Only for direct operation.  
Uniquement pour commande directe.  
只用于直接操作

pozidriv 1 / 十字螺丝刀1  
4.4 lb.in 0,5 Nm