

# MULTIS L50

## Digital panel meter

three-phases - via CT up to 6000 A dimensions 96 x 96 mm



MULTIS L50

### The solution for

- > Industry
- > Infrastructure



### Strong points

- > Large backlit LCD display
- > Direct display of multimeasurement and metering values
- > RS485 MODBUS communication
- > Inputs/Output for control/command or pulses

### Conformity to standards

- > IEC 62053-21 class 1
- > IEC 62053-23 class 2



### Function

The MULTIS L50 is a panel mounted digital meter displaying multi-measurement and energy values directly on its large backlit LCD display. It is designed for utilisation on three-phase or single-phase networks with connection via CT and is suitable for applications of up to 6000 A. The product can be configured by the user via the keypad and the display.

### Advantages

#### Easy to use

Thanks to its large backlit LCD display and its multiple viewing screens with direct pushbutton access, MULTIS L50 provide clear readings and are easy to use. They directly display a number of multi-measurement and metering values.

#### Advanced functionalities

The MULTIS L50 offers input/output functions as standard and has a pulse output or RS485 MODBUS communication output.

### Principle diagram

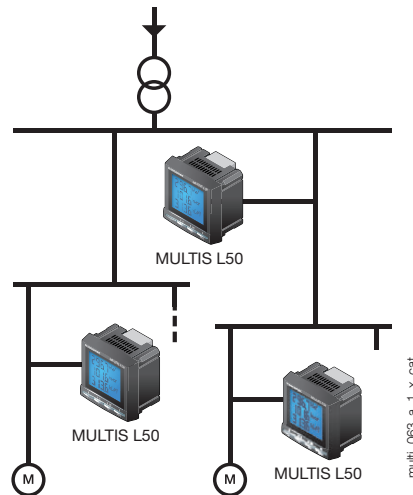

## Functions

#### Multi-measurement

- Currents
  - instantaneous: I1, I2, I3, In
  - maximum average: I1, I2, I3, In
- Voltages & frequency
  - instantaneous: V1, V2, V3, U12, U23, U31, F
- Power
  - instantaneous: 3P, ΣP, 3Q, ΣQ, 3S, ΣS
  - maximum average: ΣP, ΣQ, ΣS
  - unbalance: U unb
- Power factors
  - instantaneous: 3PF, Σ

#### Metering

- Active energy: ± kWh
- Reactive energy: ± kvarh
- Hours: ⌚

#### Harmonic analysis

- Total harmonic distortion (level 51)
  - Currents: thd I1, thd I2, thd I3
  - Phase-to-neutral voltage: thd V1, thd V2, thd V3
  - Phase-to-phase voltage: thd U12, thd U23, thd U31

#### Communications<sup>(1)</sup>

RS485 with MODBUS protocol

#### Output

- Remote command of device
- Pulse report

#### Inputs

- Remote status device

<sup>(1)</sup> Available as an option (see the following pages).

### Front panel



1. Backlit LCD display.
2. Direct access key for currents (instantaneous and max. values), current THD.
3. Direct access key for voltages, frequency and voltage THD.
4. Pushbutton for active, reactive, and apparent power (instantaneous and max. values) and power factor.
5. Direct access key for energies, hour meter and programming menu.

### Case

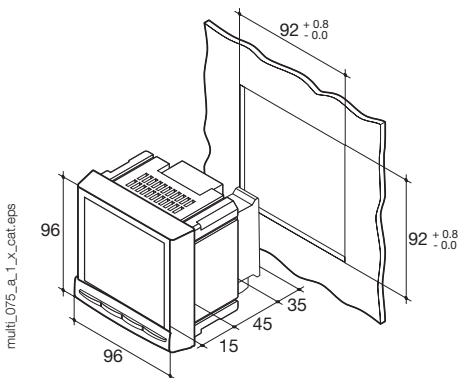

Type	panel mounting
Dimensions W x H x D	96 x 96 x 60 mm
Case degree of protection	IP30
Front degree of protection	IP52
Display type	backlit LCD display
Terminal block type	fixed or plug-in
Voltage and other connection cross-section	0.2 ... 2.5 mm <sup>2</sup>
Current connection cross-section	0.5 ... 6 mm <sup>2</sup>
Weight	400 g

### Plug-in modules

#### MULTIS L50



#### 1 Output

- 1 output assignable to:
- Pulses: configurable (type, weight, duration) in kWh or kvarh.
  - Remote command of device.



#### Communication

RS485 link with JBUS / MODBUS protocol (speed up to 38400 bauds)



#### 3 inputs, 1 output

- 3 inputs assignable to:
- Remote status device.
- 1 output assignable to:
- Pulses: configurable (type, weight, duration) in kWh or kvarh.
  - Remote command of device.

### Accessories

#### Current transformers

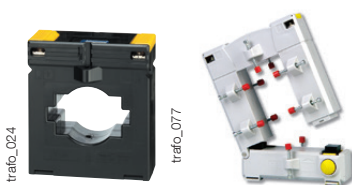

#### IP65 protection



#### Panel mounting kit for a 144 x 96 mm cut-out



# MULTIS L50

Digital panel meter

three-phases - via CT up to 6000 A dimensions 96 x 96 mm

## Electrical characteristics

Current measurement (TRMS)	
Via CT primary	9 999 A
Via CT secondary	5 A
Measurement range	0 ... 11 kA
Input consumption	0.6 VA
Measurement updating period	1 s
Accuracy	1%
Permanent overload	6 A
Intermittent overload	10 I <sub>n</sub> for 1 s
Voltage measurements (TRMS)	
Direct measurement between phases	50 ... 500 VAC
Direct measurement between phase and neutral	28 ... 289 VAC
Input consumption	≤ 0.1 VA
Measurement updating period	1 s
Accuracy	1%
Permanent overload	800 VAC
Power measurement	
Measurement updating period	1 s
Accuracy	1%
Power factor measurement	
Measurement updating period	1 s
Accuracy	1%
Frequency measurement	
Measurement range	45 ... 65 Hz
Measurement updating period	1 s
Accuracy	0.1 %

Energy accuracy	
Active (according to IEC 62053-21)	Class 1
Reactive (according to IEC 62053-23)	Class 2
Auxiliary power supply	
Alternating voltage	110 ... 250 VAC
AC tolerance	± 10 %
Direct voltage	120 ... 250 VDC
DC tolerance	± 10%
Frequency	50 / 60 Hz
Consumption	10 VA
Pulse or alarm output	
Number	1
Type	100 VDC - 0.5 A - 10 VA
Max. number of operations	≤ 10 <sup>8</sup>
Inputs	
Number	3
Power supply	10 ... 30 VDC
Minimum signal width	10 ms
Minimum duration between 2 pulses	18 ms
Type	Phototransistors
Communication	
Link	RS485
Type	2 ... 3 half duplex wires
Protocol	MODBUS RTU
MODBUS® speed	1400 ... 38400 bauds
Operating conditions	
Operating temperature	- 10 ... + 55 °C
Storage temperature	- 20 ... + 85 °C
Relative humidity	95 %

## Terminals

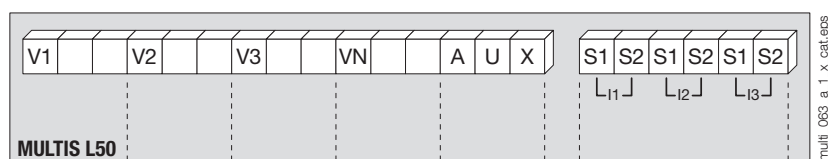

S1 - S2: current inputs.

AUX: auxiliary power supply U<sub>s</sub>.  
V1, V2, V3 & VN: voltage inputs.

### Communication module

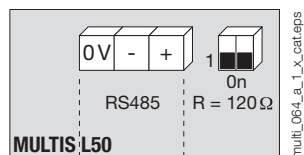

RS485 link.

R = 120 Ω: selectable internal resistance for RS485 end of line termination.

### Output or alarm module

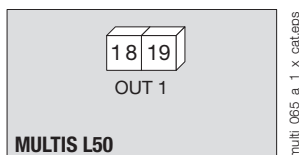

18 - 19: output n°1

### 3 inputs, 1 output module

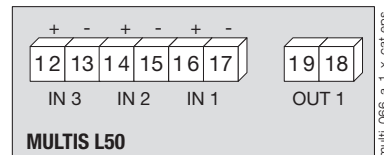

## Connection

### Recommendation:

- For IT earthing systems, it is recommended that the CT secondary is not connected to earth.
- When disconnecting the DIRIS, the secondary of each current transformer must be short-circuited. This operation can be carried out automatically by a SOCOMEC PT1, an accessory which is included in this catalogue. Please consult us.

### Low voltage balanced network

#### 3/4 wires with 1 CT

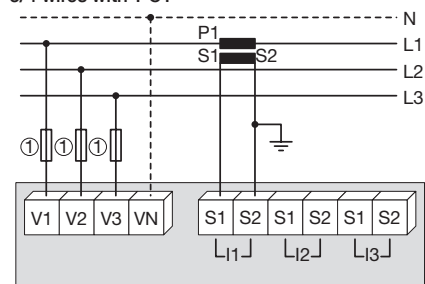

Use of 1 CT reduces by 0.5% the accuracy of the phases, the current of which is worked out by vector calculation.  
1. Fuses 0.5 A gG / 0.5 A class CC.

#### Single-phase

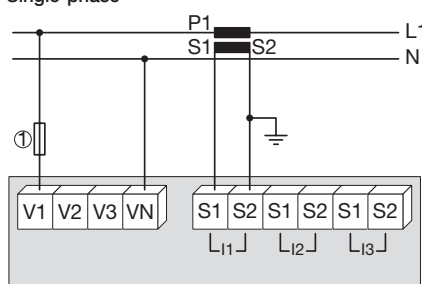

1. Fuses 0.5 A gG / 0.5 A class CC.

#### Two-phase

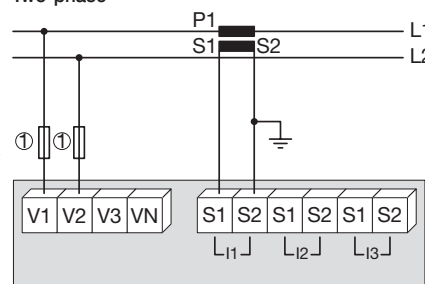

1. Fuses 0.5 A gG / 0.5 A class CC.

#### Low voltage unbalanced network

##### 3/4 wires with 3 CTs

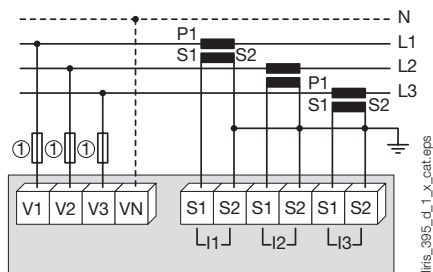

1. Fuses 0.5 A gG / 0.5 A class CC.

##### 3 wires with 2 CTs

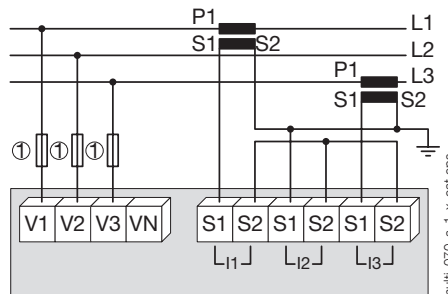

Use of 2 CTs reduces by 0.5% the accuracy of the phases, the current of which is worked out by vector calculation.

1. Fuses 0.5 A gG / 0.5 A class CC.

##### 3 wires with 2 CTs

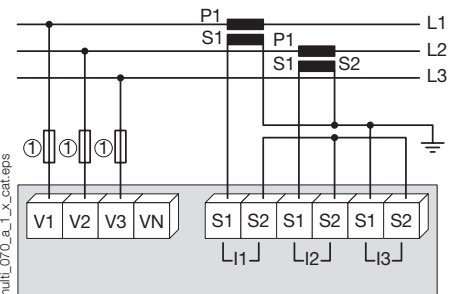

Use of 2 CTs reduces by 0.5% the accuracy of the phases, the current of which is worked out by vector calculation.

1. Fuses 0.5 A gG / 0.5 A class CC.

#### Additional information

##### Communication via RS485 link

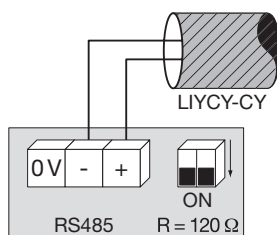

##### AC & DC auxiliary power supply

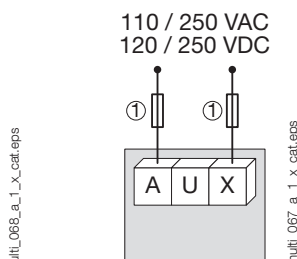

1. Fuses 0.5 A gG / 0.5 A class CC.

## References

Basic device		MULTIS L50
MULTIS L50		Reference 192J 9120
Optional plug-in modules		Reference
1 output		4825 0080
RS485 MODBUS® communication		4825 0082
3 inputs, 1 output		4825 0083
Accessories		
Description of accessories		To be ordered in multiples of
IP65 protection		1
Panel mounting kit for a 144 x 96 mm cut-out		1
Fuse holder for the protection of voltage inputs (type RM) 3 poles		4
Fuse holder for the protection of the auxiliary supply (type RM) 1 pole + neutral		6
Fuse type gG 10x38 0.5 A		10
Ferrite to be associated with communication modules		1
Current transformer range		1
		Reference
		4825 0089
		4825 0088
		5601 0018
		5601 0017
		6012 0000
		4899 0011
		See "TE sensors" pages

#### Expert Services

- > Study, definition, advice, implementation, maintenance and training... Our experts "Expert Services" offer complete support for the success of your project.

