

STEP 1

STEP 2

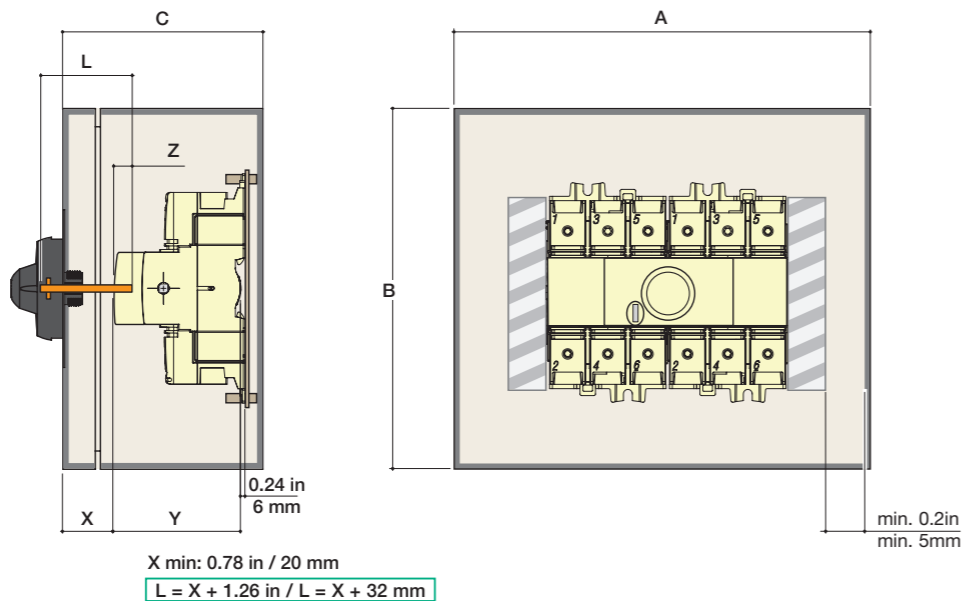
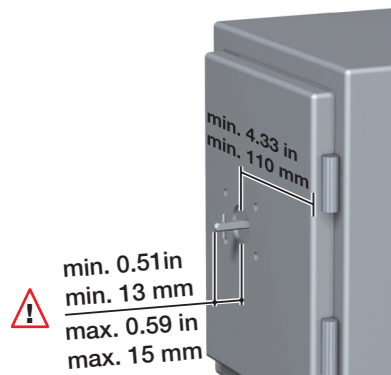

Dual dimensions in/mm
Double dimensions in/mm
Doble dimensiones in/mm

Add. Pole
Pole additionnel
Polo adicional



Aux. Contacts
Contacts aux.
Contactos auxiliares

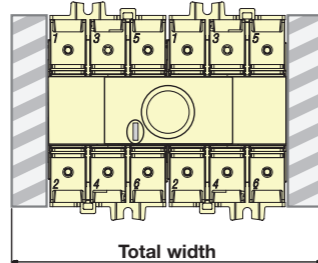
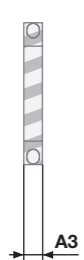

Total width = A1 + x A2 + y A3

if x = 0 y = 2 max
if x = 1 y = 2 max
if x = 2 y = 2 max

Changeover switch
Commutateur
Commutador

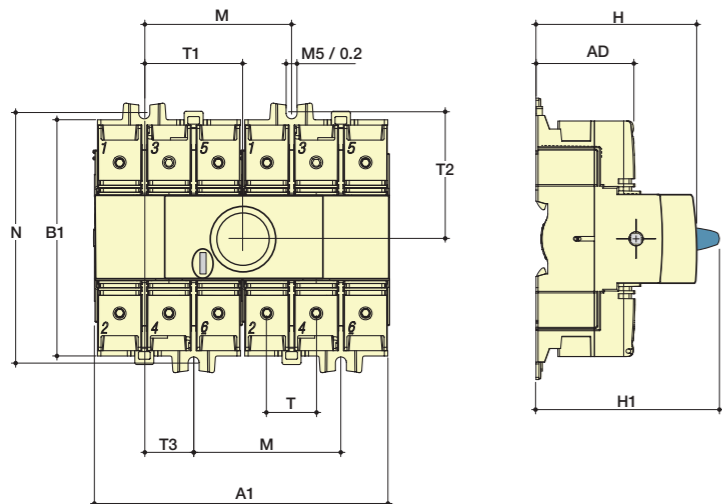

M 30 to M 125		
	in	mm
A	11.81	300
A1	6.26	159
A2	1.02	26
A3	0.34	8,8
AD	1.96	50
B	11.81	300
B1	4.90	124,5
C	5.91	150
H	3.32	84,5
H1	3.93	100
N	5.17	131,5
M	3.13	79,6
T	1.02	26
T1	2.08	52,8
T2	2.58	65,7
T3	1.02	26
Y	3.09	78,5
Z min.	0.50	12,8
Z max.	0.70	17,8

KIT CHANGEOVER SWITCH / SWITCH 6P/8P M 100 - M 125

- GB Instruction sheet
- F Notice d'utilisation
- E Instrucciones de servicio

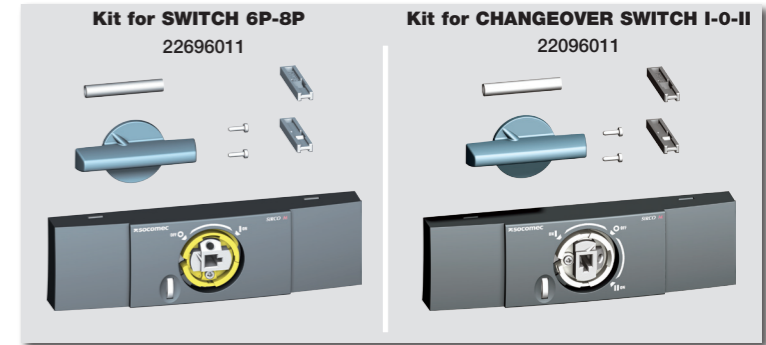

Edition 04/12 - IS 540397-A / RECTO-VERSO / S blanc offset quadri 80g/m²

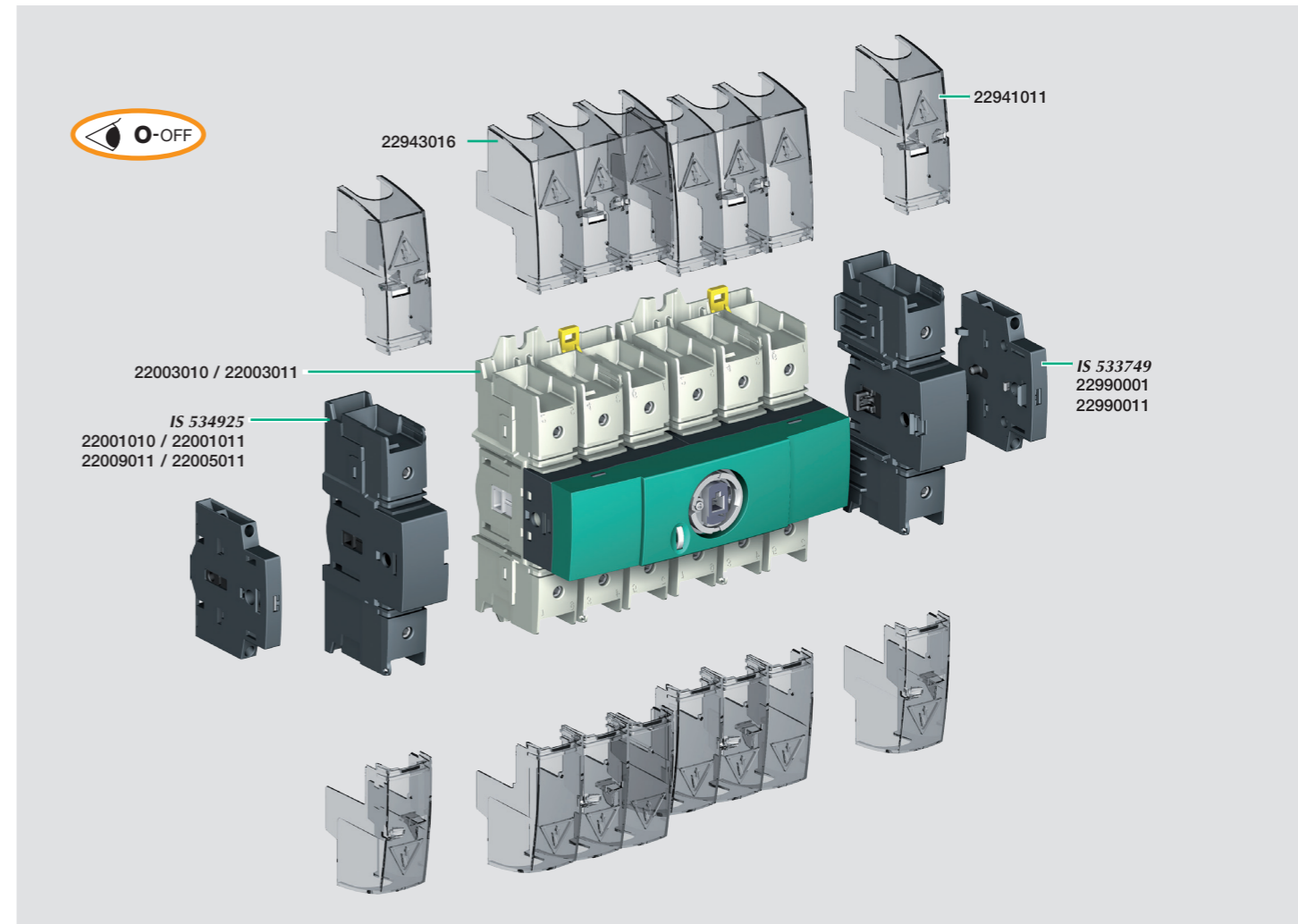

Use copper conductors only, 75°C or higher.

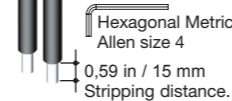

Wire / Câble / Cable	Torque / Couple / Par de apriete
10 to 1 AWG stranded	35.4 lb.in / 4 Nm
1/0 AWG stranded	39.8 lb.in / 4,5 Nm
2/0 AWG stranded	44.3 lb.in / 5 Nm
2/0 AWG compact stranded	48.7 lb.in / 5,5 Nm
# 12 to # 10 AWG solid	35.4 lb.in / 4 Nm
6 mm² - 70 mm²	35.4 lb.in / 4 Nm
2 x 6 mm² - 2 x 50 mm²	35.4 lb.in / 4 Nm

HAZARDOUS VOLTAGE / PELIGRO

HAZARDOUS VOLTAGE. This equipment must be installed and serviced only by qualified electrical personnel. Turn off all power supplying this equipment before working on or inside equipment. Always use a properly rated voltage sensing device to confirm power is off. Replace all devices, doors, and covers before turning on power to this equipment. **Failure to follow these instructions will result in death or serious injury.**

TENSION DANGEREUSE. L'installation et l'entretien de cet appareil ne doivent être effectués que par du personnel qualifié. Coupez l'alimentation de cet appareil avant d'y travailler. Utilisez toujours un dispositif de détection de tension à valeur nominale appropriée pour confirmer que toute alimentation est coupée. Remplacez tous les dispositifs, les portes et les couvercles avant de mettre cet appareil sous tension. **Si ces précautions ne sont pas respectées, cela entraînera la mort ou des blessures graves.**

TENSION PELIGROSA. Solamente el personal de mantenimiento eléctrico especializado deberá instalar y prestar servicios de mantenimiento a este equipo. Desenergice el equipo antes de realizar cualquier trabajo en él. Siempre utilice un dispositivo detector de tensión adecuado para confirmar la desenergización del equipo. Vuelva a colocar todos los dispositivos, las puertas y las cubiertas antes de energizar este equipo. **El incumplimiento de estas precauciones podrá causar la muerte o lesiones serias.**

Mounting kit for SWITCH 6-8P / M 100 - M 125

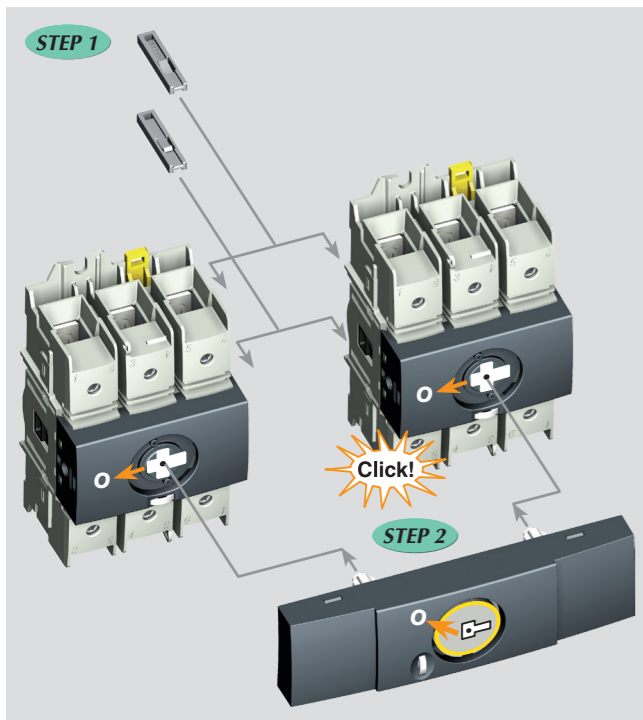

⚠ Only for 22003010 / 22003011

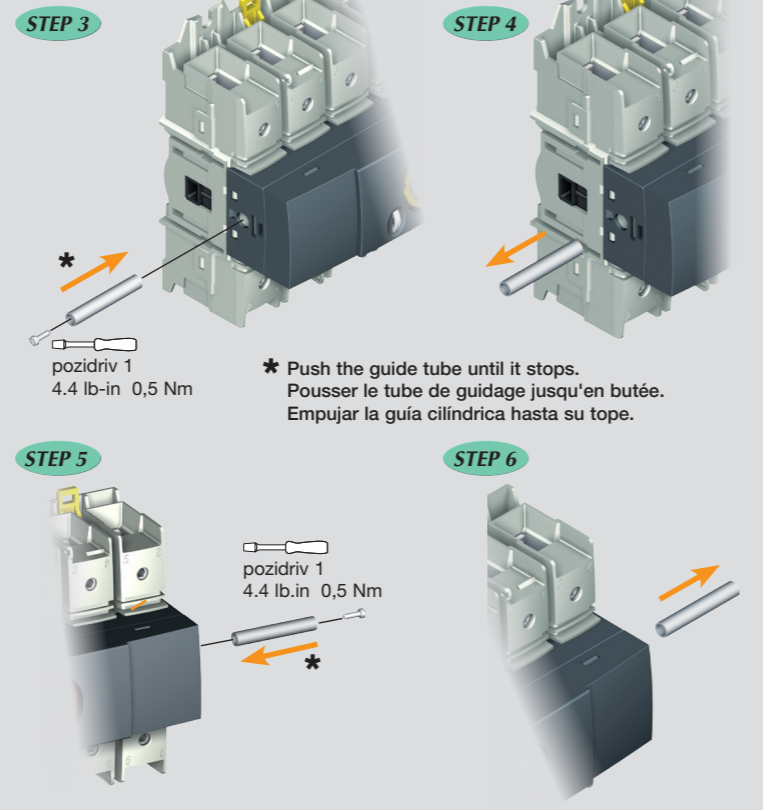

Mounting kit for CHANGEOVER SWITCH I-O-II / M 100 - M 125

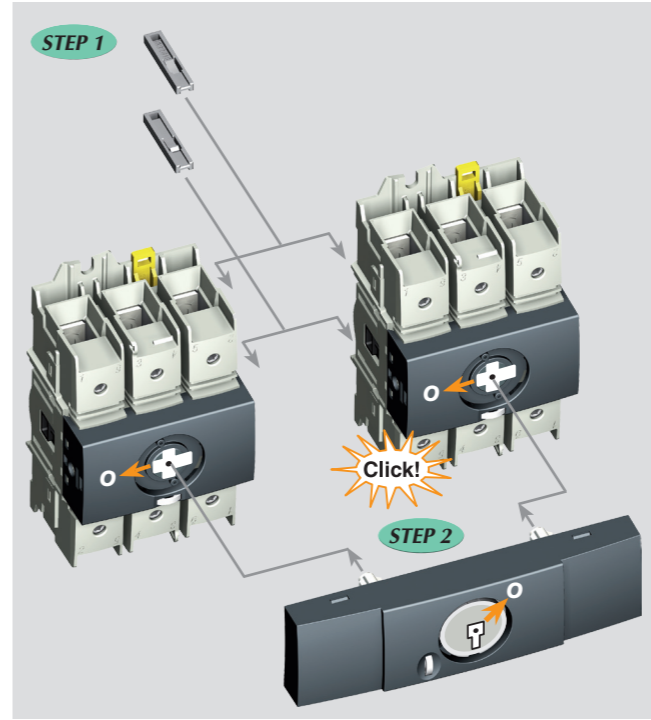

⚠ Only for 22003010 / 22003011

