

# ATyS M range

ATyS *d* M, ATyS *t* M, ATyS *g* M, ATyS *p* M  
from 40 to 160 A

## Accessories

### Bridging bars

#### Use

Used to bridge the outgoing common connection between switch I and switch II. The bridging bar does not reduce the connection capacity of the cage terminals.

Rating (A)	No. of poles	Reference
40 ... 125	2 P	1309 <b>2006</b>
160	2 P	1309 <b>2016</b>
40 ... 125	4 P	1309 <b>4006</b>
160	4 P	1309 <b>4016</b>

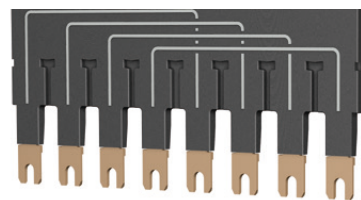

atysm\_025.eps

### Voltage sensing and power supply tap

#### Use

It allows connection of  $2 \times \leq 1.5 \text{ mm}^2$  voltage sensing or power cables.

The single-pole voltage sensing tap can be mounted in any of the terminals (incoming) without reducing their connecting capacity.

Rating (A)	Pack	Reference
40 ... 160	2 pieces	1399 <b>4006</b>

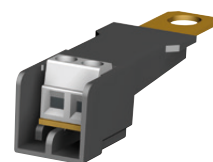

atysm\_026\_a.eps

### Terminal shrouds

#### Use

Protection against direct contact with terminals or connecting parts.

#### Advantages of the terminal shrouds

Perforations allow remote thermographic inspection without the need to remove the shrouds. Possibility of sealing.

#### Mounting

For complete upstream and downstream protection of 4 pole products, please order quantity 2; for 2 pole products please order quantity 1.

Rating (A)	Position	Reference
40 ... 160	top / bottom	2294 <b>4016<sup>(1)</sup></b>

(1) Reference composed of 2 pieces.



atysm\_027\_a.eps

### Auxiliary contact

#### Use

A maximum of two auxiliary contact blocks can be fitted to each product. Each auxiliary contact block integrates 3 NO/NC auxiliary contacts (I, O, II).

The ATyS *d* M is delivered as standard with 1 block with separate common points.

#### Characteristics:

250 VAC / 5 A maximum.

24 VDC / 2 A maximum.

Rating (A)	Type	Reference
40 ... 160	Separate common points	1309 <b>1001</b>
40 ... 160	Linked common points	1309 <b>1011</b>



access\_363.eps



access\_368.eps

### Sealable cover

#### Use

Prevents access to the ATyS *t* M and ATyS *g* M configuration panels.

Rating (A)	No. of poles	Reference
40 ... 160	2 P	1359 <b>2000</b>
40 ... 160	4 P	1359 <b>0000</b>



atysm\_313.eps

## Polycarbonate enclosure

### Use

Dedicated to the installation of a three-phase ATyS M, it enables easy integration of a compact transfer switch solution.

Rating (A)	H x W x D (mm)	Reference
40 ... 160	385 x 385 x 193	1309 9006



atysm\_036.eps

## Extension unit

### Use

Combined with the polycarbonate enclosure, the extension unit provides additional space in order to connect 70 mm<sup>2</sup> cables to the ATyS M with ease.

Rating (A)	Reference
40 ... 160	1309 9007



atysm\_039.eps

## Residential enclosure

### Use

Dedicated to the implementation of a single-phase ATyS M, the plastic enclosure provides a compact IP41 transfer switch solution with easy integration.

Rating (A)	H x W x D (mm)	Reference
40 ... 160	410 x 305 x 150	1309 9056



atysm\_196.psd

## Double power supply - DPS

### Use

Allows an ATyS *d* M to be supplied by two 230 VAC 50/60 Hz networks.

### Input

- The input is considered as "active" from 200 VAC.
- Maximum voltage: 288 VAC.
- Internal protection: each input is fuse protected (3.15 A).
- Connection on terminals: max. 6 mm<sup>2</sup>.
- Modular product: the width of 4 modules.

Description of accessories	Reference
DPS	1599 4001

Input 1	Input 2	Output
230 VAC	0 VAC	230 VAC (input 1)
0 VAC	230 VAC	230 VAC (input 2)
230 VAC	230 VAC	230 VAC (input 1)
0 VAC	0 VAC	0 VAC

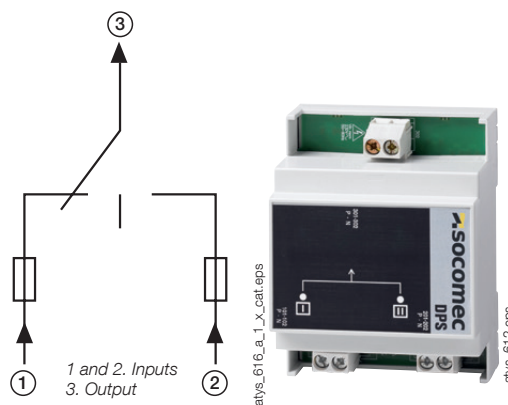

# ATyS M range

ATyS d M, ATyS t M, ATyS g M, ATyS p M

from 40 to 160 A

## Accessories (continued)

### Auto-transformer

#### Use

For use with ATyS M in 400 VAC three-phase applications that have no distributed neutral. The ATyS M includes integrated sensing and power supply circuits, therefore a neutral connection is required for 400 VAC three-phase applications. When no neutral connection is available this autotransformer (400/230 VAC, 400 VA) provides the 230 VAC required for the ATyS to function.



trafo\_165.eps

Rating (A)	Reference
40 ... 160	1599 4121

### Remote interfaces for ATyS p M

#### Use

To remotely display source availability and position indication on the front of a panel when the ATyS M is enclosed.

The remote interface is powered directly from the ATyS M via the RJ45 connection cable. Maximum cable length: 3 m.

#### D10

To display source availability and position indication on the front panel of an enclosure.

Protection degree: IP21.

#### D20

In addition to the functions of the D10, the D20 displays measurements and enables control and configuration from the front of the display panel.

Protection degree: IP21.

#### Door mounting

2 holes Ø 22.5.

ATyS M connection via RJ45 cable, not isolated.

Cable not provided.



atys\_564.eps



atys\_565.eps



atys\_597.eps

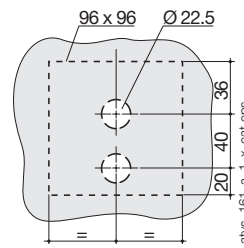

atys\_161\_a\_1\_x\_cat.eps

RJ45 to connect to ATyS p M

Drillings

Description of accessories	Reference
D10	9599 2010
D20	9599 2020

### Connecting cable for remote interfaces

#### Use

To connect between a remote interface (type D10 or D20) and a control product (ATyS p M).

#### Characteristics:

RJ45 8 wire straight-through, non isolated cable. Length 3 m.



access\_209.eps

Type	Length	Reference
RJ45 cable	3 m	1599 2009

### Cage-terminal interface

#### Use

The power connection terminals allow conversion of the cage clamp terminals into bolt-on type connection terminals, enabling connection of up to two 35 mm<sup>2</sup> cables or one 70 mm<sup>2</sup> cable. Compatible with aluminium terminals. Each power connection terminal is provided with separation screens.

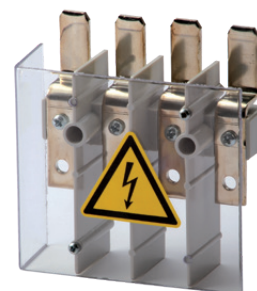

atysm\_252.psd

Rating (A)	Reference
40 ... 160	1399 4017 <sup>(1)</sup>

(1) For complete conversion, order quantity 3.

## Dimensions

### ATyS M 40 to 160 A

#### Single-phase ATyS M

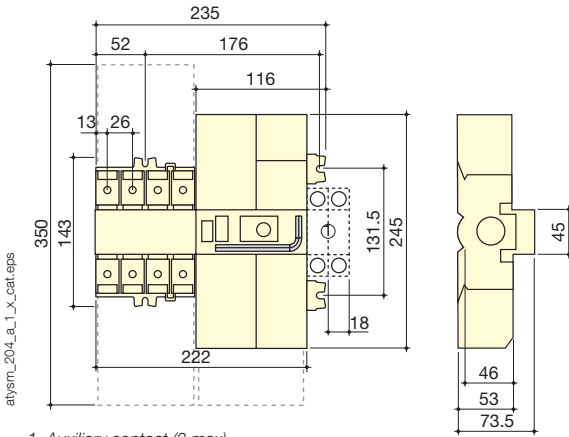

1. Auxiliary contact (2 max).

#### Three-phase ATyS M

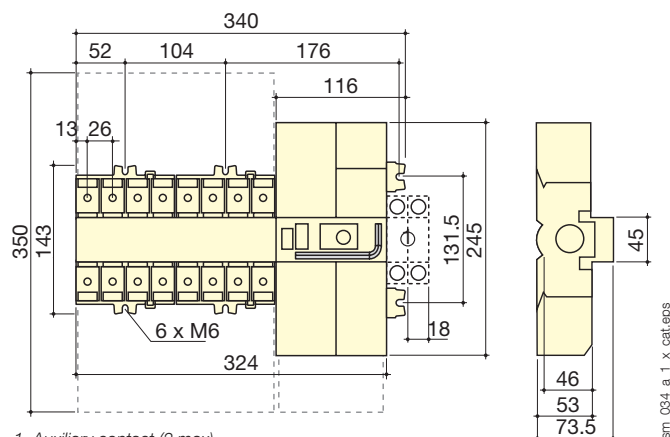

1. Auxiliary contact (2 max).

#### Single-phase ATyS M - door cut-out

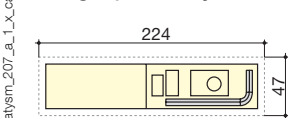

#### Three-phase ATyS M - door cut-out

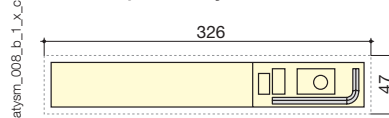

## Terminals and connections

### Single-phase ATyS d M

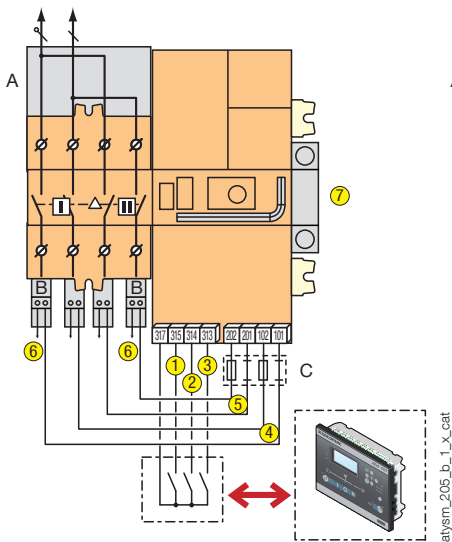

### Three-phase ATyS d M

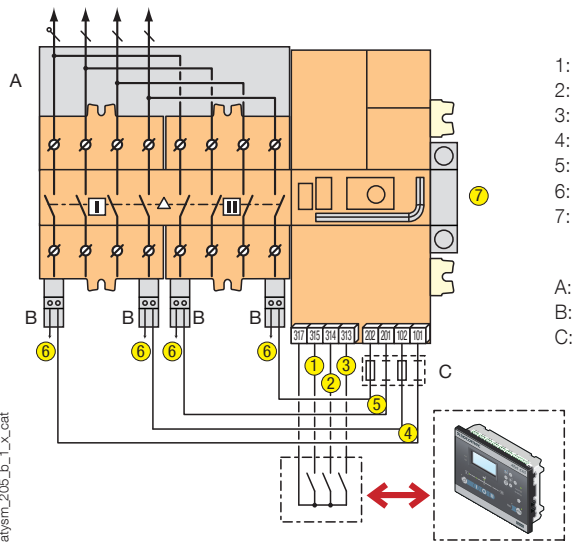

- 1: position I control
- 2: position II control
- 3: position 0 control C
- 4: power supply I (230 VAC)
- 5: power supply II (230 VAC)
- 6: voltage tap
- 7: auxiliary contact block - 1 NO/NC per position I, 0, II (factory fitted)

- A: bridging bar (accessory)
- B: voltage sensing tap (accessory)
- C: F1 / F2 = fuse 10 A gG

# ATyS M range

ATyS *d* M, ATyS *t* M, ATyS *g* M, ATyS *p* M

from 40 to 160 A

## Terminals and connections (continued)

### Three-phase ATyS t M

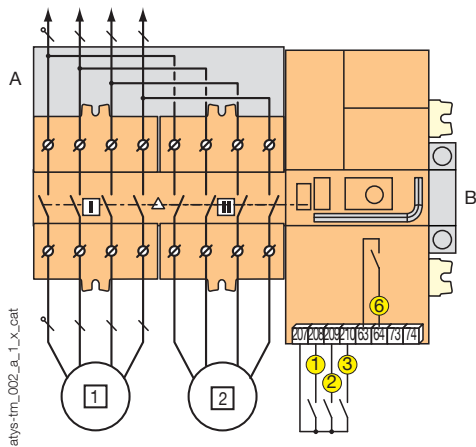

- 1 primary source (network)
- 2 backup source (network)

- 1: position 0 control
- 2: preferred source selection
- 3: automatic mode inhibition
- 6: availability S1 or S2

A: bridging bar (accessory)  
 B: auxiliary contact block - 1 NO/NC per position I, 0, II (accessory)

### Single-phase ATyS g M

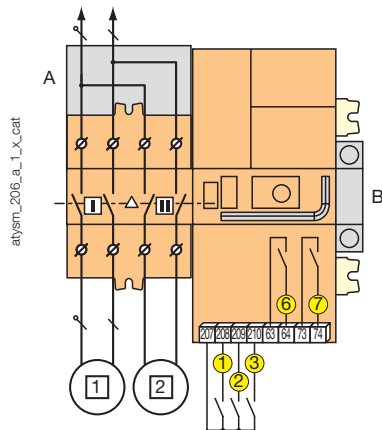

### Three-phase ATyS g M

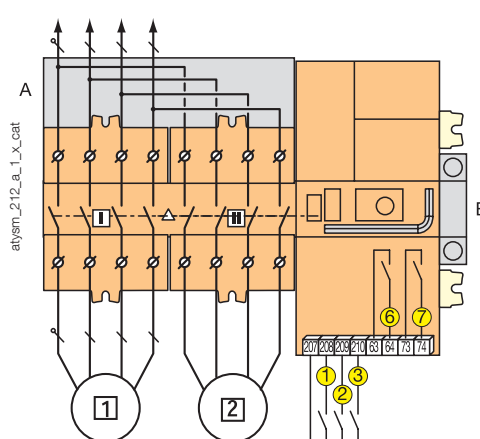

- 1 primary source
- 2 backup source

- 1: manual retransfer /priority change
- 2: test on load
- 3: automatic mode inhibition
- 6: relay for product availability
- 7: genset start / stop control

A: bridging bar (accessory)  
 B: auxiliary contact block - 1 NO/NC per position I, 0, II (accessory)

### Three-phase ATyS p M

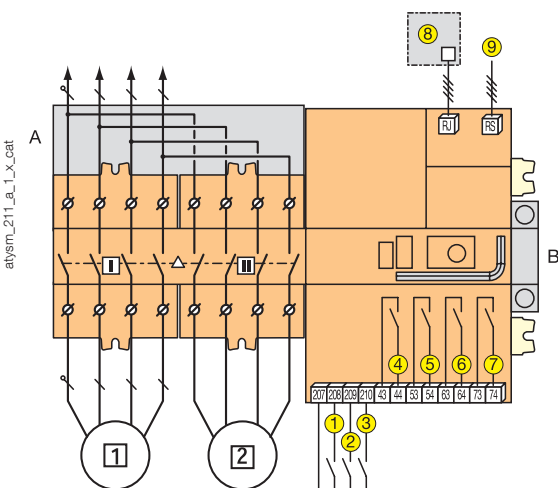

- 1 primary source
- 2 backup source

- 1 - 2 - 3: programmable inputs
- 4 - 5 - 6: programmable outputs
- 7: genset start / stop control
- 8: RJ45 for connecting a D10/D20 remote interface.
- 9: RS485 for communication on versions with COM.

A: bridging bar (accessory)  
 B: auxiliary contact block - 1 NO/NC per position I, 0, II (accessory)

## Characteristics according to IEC 60947-3 and IEC 60947-6-1

### 40 to 160 A

Thermal current $I_{th}$ at 40°C	40 A	63 A	80 A	100 A	125 A	160 A
Rated insulation voltage $U_i$ (V) (power circuit)	800	800	800	800	800	800
Rated impulse withstand voltage $U_{imp}$ (kV) (power circuit)	6	6	6	6	6	6
Rated insulation voltage $U_i$ (V) (control circuit)	300	300	300	300	300	300
Rated impulse withstand voltage $U_{imp}$ (kV) (control circuit) - ATyS d M	4	4	4	4	4	4
Rated impulse withstand voltage $U_{imp}$ (kV) (control circuit) - ATyS t M, g M and p M	2.5	2.5	2.5	2.5	2.5	2.5

### Rated operational currents $I_e$ (A) according to IEC 60947-6-1

Rated voltage	Utilisation category	A/B <sup>(1)</sup>	A/B <sup>(1)</sup>	A/B <sup>(1)</sup>	A/B <sup>(1)</sup>	A/B <sup>(1)</sup>	A/B <sup>(1)</sup>
415 VAC	AC-31 A / AC-31 B	40/40	63/63	80/80	100/100	100/125	100/160
415 VAC	AC-32 A / AC-32 B	40/40	63/63	80/80	100/100	100/125	100/160
415 VAC	AC-33 A / AC-33 B	-/40	-/63	-/80	-/100	-/125	-/125

### Rated operational currents $I_e$ (A) according to IEC 60947-3

Rated voltage	Utilisation category	A/B <sup>(1)</sup>	A/B <sup>(1)</sup>	A/B <sup>(1)</sup>	A/B <sup>(1)</sup>	A/B <sup>(1)</sup>	A/B <sup>(1)</sup>
415 VAC	AC-20 A / AC-20 B	40/40	63/63	80/80	100/100	125/125	160/160
415 VAC	AC-21 A / AC-21 B	40/40	63/63	80/80	100/100	125/125	160/160
415 VAC	AC-22 A / AC-22 B	40/40	63/63	80/80	100/100	125/125	160/160
415 VAC	AC-23 A / AC-23 B	40/40	63/63	80/80	100/100	125/125	125/160
690 VAC	AC-21 A / AC-21 B	40/40	63/63	80/80	100/100	125/125	160/160
690 VAC	AC-22 A / AC-22 B	40/40	63/63	80/80	80/80	100/125	100/125
690 VAC	AC-23 A / AC-23 B	40/40	63/63	63/63	80/80	80/80	80/80

### Current rated as conditional short-circuit with fuse gG DIN

Conditional short-circuit current (kA rms)	50	50	50	50	50	40
Associated fuse rating (A)	40	63	80	100	125	160

### Current rated as conditional short-circuit with any brand of circuit breaker that ensures tripping in less than 0.3s<sup>(4)</sup>

Current rated as short-time withstand low 0.3s (kA rms)	7	7	7	7	7	7
---	---	---	---	---	---	---

### Short-circuit operation (switch only)

Current rated as short-time withstand $I_{cw}$ 1s (kA rms) <sup>(2)</sup>	4	4	4	4	4	4
Rated peak withstand current (kA peak) <sup>(2)</sup>	17	17	17	17	17	17

### Connection

Minimum connection cross-section (mm <sup>2</sup> )	10	10	10	10	10	10
Maximum Cu cable cross-section (mm <sup>2</sup> )	70	70	70	70	70	70
Tightening torque (Nm)	5	5	5	5	5	5

### Switching time<sup>(5)</sup>

I - 0 or II - 0, following a command (ms)	45	45	45	45	45	45
Transfer time I - II or II - I, following a command (ms)	180	180	180	180	180	180
I-0 or II-0, after outage (s)	1.2	1.2	1.2	1.2	1.2	1.2
I-II or II-I transfer time, after outage (s)	1.4	1.4	1.4	1.4	1.4	1.4
Contact transfer time ("black-out") I-II min. (ms) <sup>(3)</sup>	150	150	150	150	150	150

### Power supply

Min./max. auxiliary power supply (VAC) (ATyS d M, t M and g M)	176/288	176/288	176/288	176/288	176/288	176/288
Min./max. auxiliary power supply (VAC) (ATyS p M)	160/305	160/305	160/305	160/305	160/305	160/305

### Control supply power demand

Rated power (VA)	6	6	6	6	6	6
Max. intensity at 230 VAC (A) - ATyS d M, t M and g M	30	30	30	30	30	30
Max. intensity at 230 VAC (A) - ATyS p M	20	20	20	20	20	20

### Mechanical specifications

Durability (number of operating cycles)	10,000	10,000	10,000	10,000	10,000	10,000
Weight of single-phase models - non-packaged (kg)	2.8	2.8	2.8	2.8	2.8	2.8
Weight of single-phase models - including packaging (kg)	3.5	3.5	3.5	3.5	3.5	3.5
Weight of three-phase models - non-packaged (kg)	3.5	3.5	3.5	3.5	3.5	3.5
Weight of three-phase models - including packaging (kg)	4.2	4.2	4.2	4.2	4.2	4.2

(1) Category with index A = frequent operation / Category with index B = infrequent operation.

(2) For a rated operational voltage  $U_e = 400$  VAC.

(3) 5% tolerance.

(4) Value for coordination with any circuit breaker that ensures tripping in less than 0.3s.

For coordination with specific circuit-breaker references, higher short-circuit current values are available. Please contact us.

(5) At rated voltage - excluding time delays, where applicable.