

# DIRIS B

## Multifunction measuring unit - PMD

measurement, monitoring and event analysis with smart sensors - modular format

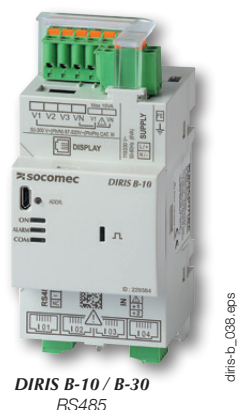

diris\_b\_038 eps



Configuration  
with Easy Config System.

### Function

The **DIRIS B** is a power monitoring device in a modular format that communicates via RS485. The 4 RJ12 independent current inputs of the device allow it to manage several types and number of circuits: for example, 4 single-phase loads or 1 three-phase load + 1 single-phase load.

The DIRIS B is connected to current sensors (RJ12 connection) that are suitable for all types of installation: solid TE, split-core TR/ITR, and flexible TF current sensors.

### Advantages

#### Plug & Play

A rapid RJ12 connection makes wiring easy and reliable and prevents wiring errors. Automatically addressing and configuring the product (communication address, load type, type and ratio of current sensor) allow you to simplify implementation and to save time.

#### Class 0.5 in accordance with IEC 61557-12

- Class 0.2 for the meter alone.
- Class 0.5 from 2% to 120% of nominal current for the global measurement chain (associated with TE/ITR/TF current sensors).

#### Multi-circuit

- 4 current measurement inputs allow you to configure multiple circuits in order to optimise the number of measurement devices per installation.

#### Communication

- The DIRIS B can be connected to:
  - a remote DIRIS D-30 screen for displaying measurement and metering data,
  - DIRIS Digiware M-50/M-70 gateways for centralisation and communication of data via Ethernet. DIRIS Digiware M-70 embeds WEBVIEW-M, a webserver for remote visualisation of measurement data,
  - optional modules for more communication options including a second RS485 port or PROFIBUS DP protocol. Digital or Analog input/output, as well as temperature input modules can also be connected.

### The solution for

- > Industry
- > Building
- > Infrastructure
- > Local authority



### Strong points

- > Plug & Play
- > Global accuracy class 0.5 in accordance with IEC 61557-12
- > Multi-circuit
- > Communication

### Integrated technologies





For more information see our website  
[www.socomec.com](http://www.socomec.com)

### Conformity to standards

- > UL E257746
- > IEC 61557-12
- > EN 50160
- > ISO 14025



Application	Local metering	Local analysis
		
<b>DIRIS B</b>	<b>B-10</b> RS485	<b>B-30</b> RS485
Number of current inputs	4	4
<b>Metering</b>		
± kWh, ± kvarh, kVAh	•	•
Load curves		•
Multi-tariff	•	•
<b>Multi-measurement</b>		
U12, U23, U31, V1, V2, V3, f	•	•
U system, V system	•	•
I1, I2, I3, In, ΣP, ΣQ, ΣS, ΣPF	•	•
P, Q, S, PF per phase	•	•
Predictive power	•	•
Ph/N unbalance	•	•
Ph/Ph unbalance	•	•
Current unbalance (Inba, Idir, linv, lhom, lnb)	•	•
Phi, cos Phi, tan Phi	•	•
<b>Quality analysis</b>		
THDv1, THDv2, THDv3, THDu12, THDu23, THDu31	•	•
THDi1, THDi2, THDi3, THDin	•	•
Individual harmonics U & V (up to 63 <sup>rd</sup> )		•
Individual harmonics I (up to 63 <sup>rd</sup> )		•
Crest factor I1, I2, I3, In		•
Crest factor V1, V2, V3, U12, U23, U31		•
Voltage dips, interruptions, swells (EN 50160)		•
Overcurrents		•
<b>Alarms</b>		
On threshold		•
Inputs/outputs		•
<b>History of average values</b>		
45 days (max)		•
<b>Communication</b>		
RS485 Modbus	•	•
2 inputs (status/pulse)	•	•

## Accessories

### DIRIS B sealing cover

- Prevents access to the cabling of the monitoring device.

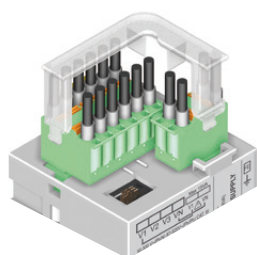

### USB configuration cable (2 m)

- Advanced configuration of DIRIS B gateways can be achieved using the EASY CONFIG software via Ethernet or direct USB connection.

# DIRIS B

## Multifunction measuring unit - PMD

measurement, monitoring and event analysis with smart sensors - modular format

### DIRIS D-30 display

DIRIS D-30



diris-d\_001\_a\_1\_cat

Connection



diris-d\_004\_b\_1\_LX\_cat

DIRIS D-30

DIRIS B

### Optional modules

DIRIS O



diris-b\_001\_a

Optional module

DIRIS B

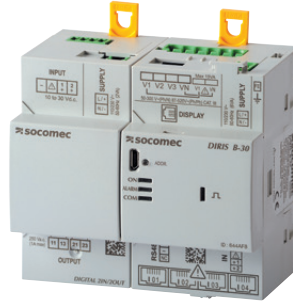

#### Optional modules (4 max.)\*

- Digital inputs/outputs
- Analogue inputs/outputs
- Temperature inputs
- Communication protocols

\* maximum 4 optional modules with maximum 1 temperature module and 1 communication module (Modbus, PROFIBUS).



diris-o\_019\_a

#### DIRIS O-iod

- 2 digital inputs centralises the metering pulses or the input status changes of the auxiliary contacts.
- 2 digital outputs can be connected to configurable alarms warning of exceeded thresholds (power, current, etc.) or can be piloted remotely.



diris-o\_018\_a

#### DIRIS O-ioa

- 2 inputs (4-20 mA) centralise analogue sensors (pressure, humidity, temperature, etc.)
- 2 outputs (4-20 mA) report the measurements (power, currents, etc.) to PLCs.



diris-o\_020\_a

#### DIRIS O-it

- 3 temperature inputs to be connected to PT100 or PT1000 sensors.
- Ambient air temperature.



diris-o\_024\_a

#### DIRIS O-m

- Provides a second RS485 Modbus communication port to the DIRIS B for simultaneous sending of information via RS485 to two supervision stations.



diris-o\_023\_a

#### DIRIS O-p

- Adds a PROFIBUS DPV1 communication port to the DIRIS B.

#### DIRIS B terminals

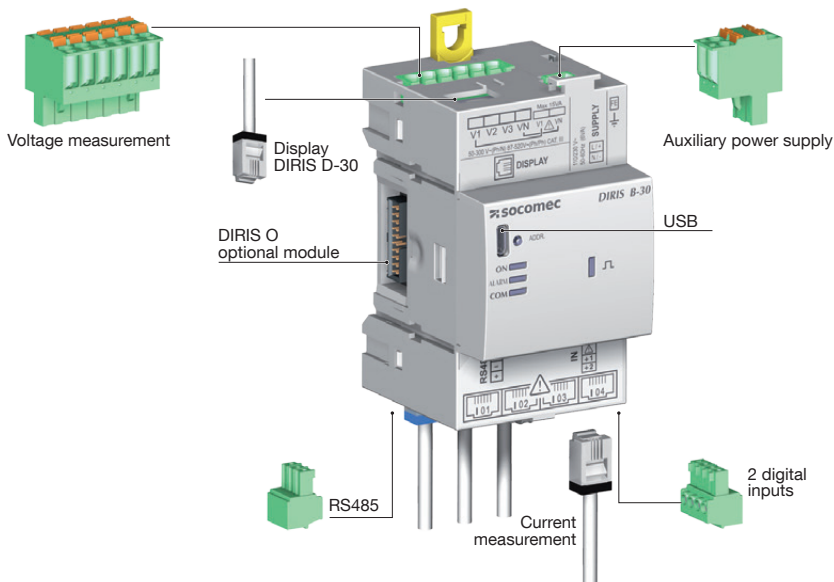

diris-d\_027\_b\_1\_gb\_cat

#### Current measurement

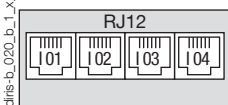

#### Voltage measurement and auxiliary power supply

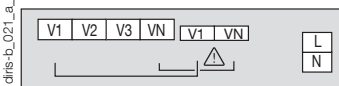

#### 2 inputs supplied by the product

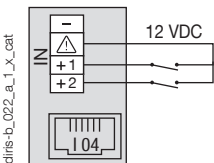

diris-b\_022\_a\_1\_x\_cat

#### Self supply

Easy connection of the power supply from the measurement terminal (specific terminals)

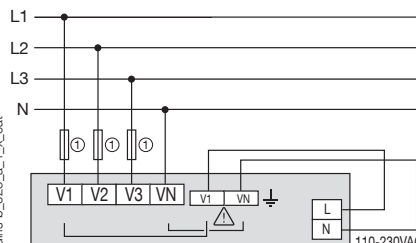

1. Fuses 0.5 A gG / 0.5 A class CC.

#### 2 inputs with external power supply

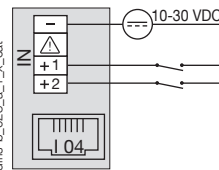

diris-b\_023\_a\_1\_x\_cat

#### Separate power supply

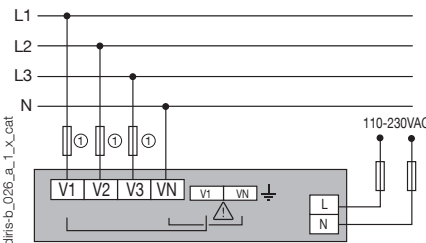

1. Fuses 0.5 A gG / 0.5 A class CC.

#### RS485

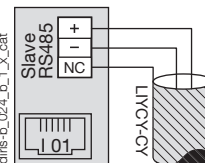

diris-b\_024\_b\_1\_x\_cat

#### RJ9 for DIRIS D-30 (self-supply and data)



diris-b\_019\_a\_1\_x\_cat

#### Terminals of optional DIRIS O modules

#### Optional module power supply

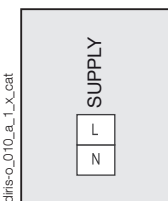

diris-o\_010\_a\_1\_x\_cat

#### DIRIS O-iod

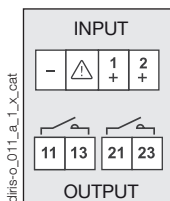

diris-o\_011\_a\_1\_x\_cat

#### DIRIS O-ioa

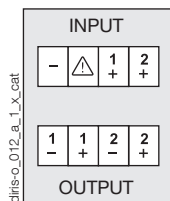

diris-o\_012\_a\_1\_x\_cat

#### DIRIS O-it

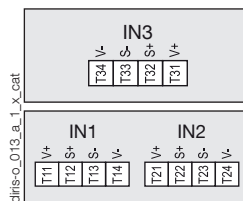

diris-o\_013\_a\_1\_x\_cat

#### DIRIS O-m RS485

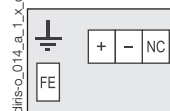

diris-o\_014\_a\_1\_x\_cat

#### DIRIS O-p

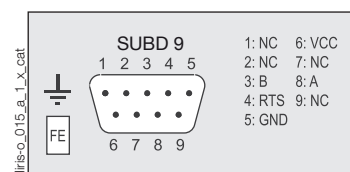

diris-o\_015\_a\_1\_x\_cat

# DIRIS B

## Multifunction measuring unit - PMD

measurement, monitoring and event analysis with smart sensors - modular format

### Connections

#### Associated current sensors

Various types of current sensors can be connected to the DIRIS B: solid-core TE, split-core TR/iTR, flexible TF current sensors. This range of sensors can be adapted to all types of new or existing installations. A rapid RJ12 connection makes wiring easy and reliable and prevents wiring errors. The DIRIS B automatically recognises the type of sensor used and its current rating. This guarantees the overall accuracy of the DIRIS B + current sensor measurement chain. For more information: see "TE, TR/iTR, TF sensors" pages.

TE solid-core current sensors

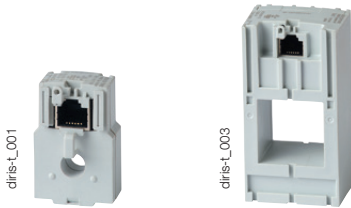

TR/iTR split-core current sensors



TE / TR / iTR / TF current sensors

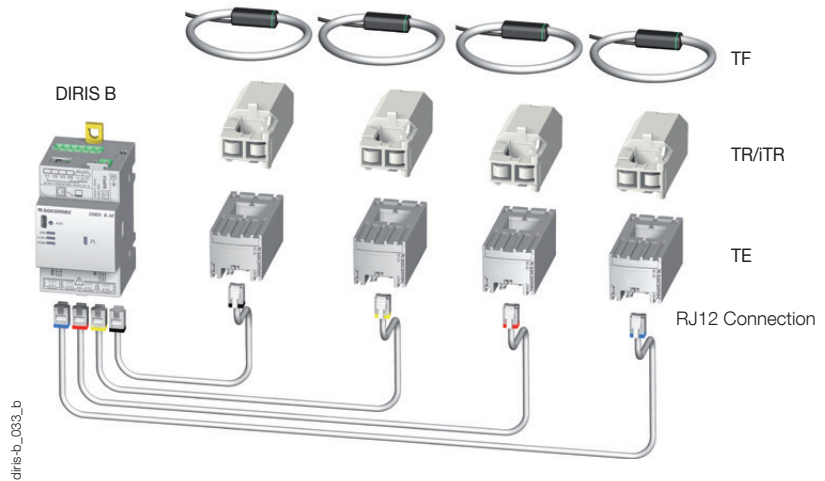

#### Network and connection examples

##### Three-phase + neutral

3P+N - 4CTs (measurement for 1 three-phase load + Neutral)

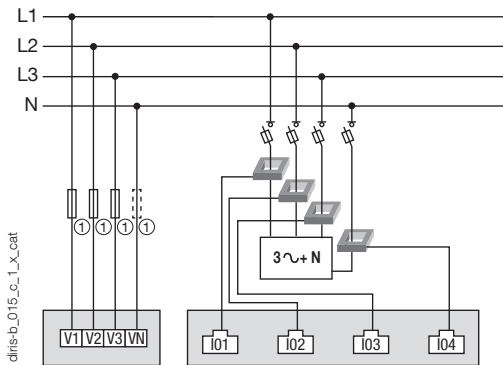

1. Fuses 0.5 A gG / 0.5 A class CC.

##### Three-phase

3P - 2CTs (2 three-phase loads without neutral)

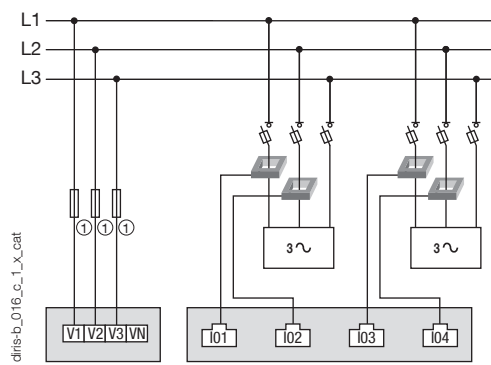

1. Fuses 0.5 A gG / 0.5 A class CC.

##### Three-phase

3P+N - 3CTs & 1P+N - 1CT (1 three-phase load & 1 single-phase load)

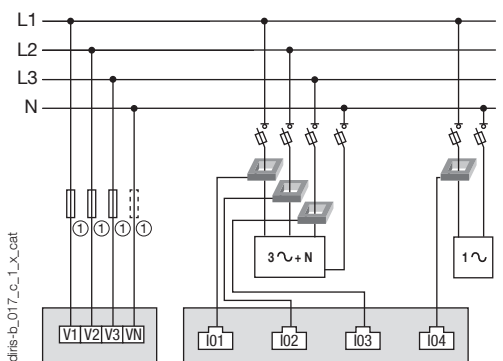

1. Fuses 0.5 A gG / 0.5 A class CC.

In case of self-supply, a fuse must be added on the neutral.

##### Single-phase

1P+N-1CT (4 single-phase loads)

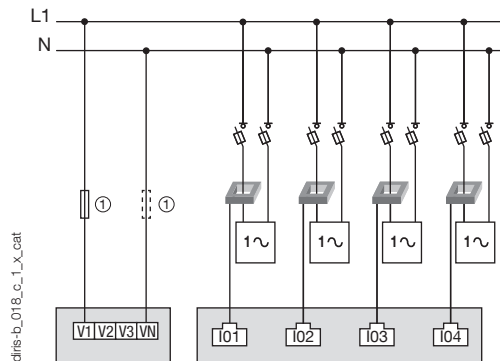

1. Fuses 0.5 A gG / 0.5 A class CC.



#### Dimensions (mm)

##### DIRIS B

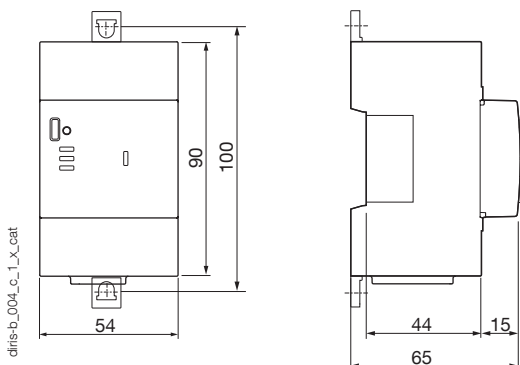

##### DIRIS O optional modules

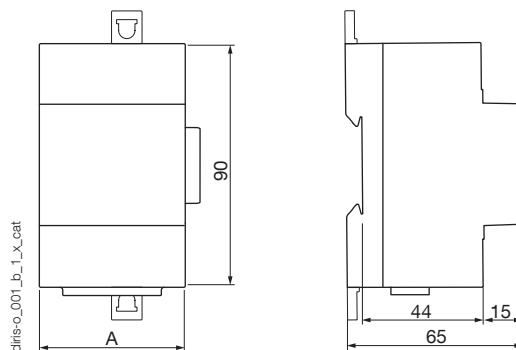

DIRIS O optional modules	A (mm)
DIRIS O-iod - DIRIS O-ioa - DIRIS O-it	45
DIRIS O-m - DIRIS O-p	54

##### DIRIS D-30

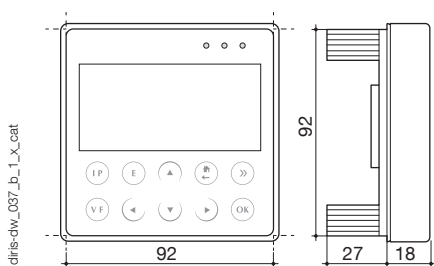

#### Communication architecture

Example of communication architecture with DIRIS Digiware M-70 gateway and WEBVIEW-M embedded web server.

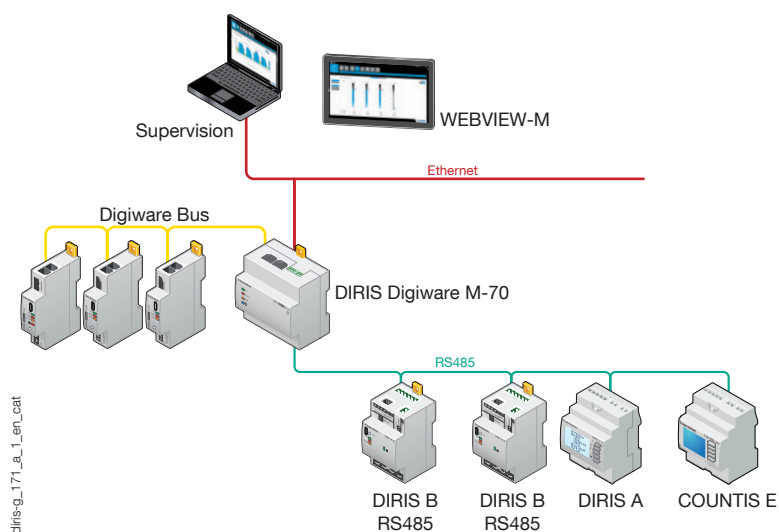

# DIRIS B

## Multifunction measuring unit - PMD

measurement, monitoring and event analysis with smart sensors - modular format

### DIRIS B characteristics

#### Electrical characteristics

Auxiliary power supply	
AC voltage	110-230 VAC ±15 % (Ph/N ou Ph/Ph) Cat III
Frequency	50/60 Hz
Consumption	< 2 VA without display < 6VA with display
Connection	Removable spring-cage terminal, 2 x 2 positions, 0.5 ... 2.5 mm <sup>2</sup> solid cable or 0.25 ... 1.5 mm <sup>2</sup> stranded cable with ferrule

#### Measurement characteristics

Energy and power measurement	
Accuracy	Class 0.2 DIRIS B alone
Active energy and active power	Class 0.5 with TE, iTR or TF current sensors Class 1 with TR current sensors
Reactive energy accuracy	Class 2 with TE, TR or TF current sensors

Power factor measurement	
Accuracy	Class 0.5 with TE, iTR or TF current sensors Class 1 with TR current sensors

Voltage measurement	
Network characteristics measured	50-300VAC (PhN) - 87-520VAC (Ph/Ph) - CAT III
Frequency range	45 ... 65Hz
Frequency accuracy	Class 0.02
Network type	Single-phase / Two-phase / Two-phase with neutral / Three-phase / Three-phase with neutral
Measurement by voltage transformer	Primary: 400 000 VAC Secondary: 60, 100, 110, 173, 190 VAC
Input consumption	≤ 0.1 VA
Permanent overload	300VAC Ph/N
Voltage measurement accuracy	Class 0.2

Current measurement	
Number of current inputs	4
Associated current sensors	Solid TE , split-core TR/iTR , flexible TF current sensors
Accuracy	Class 0.2 DIRIS B alone Class 0.5 with TE, iTR or TF current sensors Class 1 with TR current sensors

#### Input characteristics

Number	2
Type / Power supply	Optocoupler internal polarisation (12 VDC ± 10 %) or external polarisation (10-30 VDC ± 10%)

#### Communication characteristics

DIRIS B RS485	
Link	RS485
Connection type	2 ... 3 half duplex wires
Protocol	Modbus RTU
Speed	1200 ... 115200 bauds
USB	DIRIS B RS485 configuration

#### Environment characteristics

Operating temperature	-10 ... +70 °C
Storage temperature	-25 ... +85 °C
Operating humidity	55 °C / 97% relative humidity
Operating altitude	2000 m
Vibration	1G from 10 to 100Hz

### DIRIS D-30 display characteristics

Mechanical characteristics	
Screen type	Capacitive touch-screen technology, 10 keys
Screen resolution	350 x 160 pixels
Single product connection	
RJ9	Self-supply and data
Micro-USB	Updating
Degree of protection	IP65 (front face)
Environment	
Storage temperature (°C)	-20 ... +70°C
Operating temperature (°C)	-20 ... +70°C
Humidity	95 % to 40°C
Installation category	CAT III
Degree of pollution	2

### DIRIS O optional modules characteristics

Power supply <sup>(1)</sup>	
AC voltage	110-230 VAC ±15 %
Frequency	50/60 Hz

(1) No power supply on DIRIS O-it.

DIRIS O-iod - 2 digital inputs/2 digital outputs	
Number of inputs	2 per optional modules - max. 4 optional modules
Type	Optocoupler internal polarisation (12 VDC ± 10 %) or external polarisation (10-30 VDC ± 10%)
Function	Logic status or pulse meter
Number of outputs	2 per optional modules - max. 4 optional modules
Type	Relay / 230 VAC ±15 % - 1 A
Function	Configurable alarm (current, power...) on threshold overruns or remote controlled status
Inputs/Outputs connection	Removable screw terminal, 4 positions, 0.14 to 1.5 mm <sup>2</sup> stranded or solid cable

DIRIS O-ioa - 2 analogue inputs/2 analogue outputs	
Number of inputs	2 per optional modules - max. 4 optional modules
Type	4-20 mA
Function	Connection of analogue sensors (pressure, humidity, temperature...)
Number of outputs	2 per optional modules - max. 4 optional modules
Type	4-20 mA

DIRIS O-it - 3 temperature inputs	
Number of inputs	3 external inputs + 1 measurement for ambient temperature
Dynamic	-20 ... 150 °C
Type	PT100 or PT1000

DIRIS O-m - RS485 communication	
Link	RS485 2 ... 3 half duplex wires
Protocol	Modbus RTU
Speed	1200 ... 115200 bauds
Connection	Removable screw terminal, 3 positions, 0.14 to 1.5 mm <sup>2</sup> stranded or solid cable

DIRIS O-p - PROFIBUS communication	
Protocol	PROFIBUS DPV1

**References**

<b>DIRIS B monitoring devices</b>		<b>Reference</b>
DIRIS B-10	RS485 - Modbus - 230 VAC	4829 <b>0010</b>
DIRIS B-30	RS485 - Modbus - 230 VAC	4829 <b>0000</b>
<b>DIRIS O optional modules</b>		<b>Reference</b>
DIRIS O-iod	2 digital inputs / 2 digital outputs	4829 <b>0030</b>
DIRIS O-ioa	2 analogue inputs/2 analogue outputs 4-20 mA	4829 <b>0031</b>
DIRIS O-it	3 temperature inputs PT 100 / PT 1000	4829 <b>0032</b>
DIRIS O-m	RS485 Modbus communication	4829 <b>0033</b>
DIRIS O-p	PROFIBUS communication	4829 <b>0034</b>
<b>Accessories</b>	<b>To be ordered in multiples of</b>	<b>Reference</b>
DIRIS D-30 - Single-point display		4829 <b>0200</b>
RJ9 cable for DIRIS D-30 display - 1.5 m		4829 <b>0280</b>
RJ9 cable for DIRIS D-30 display - 3 m		4829 <b>0281</b>
DIRIS B sealing cover for I/O terminals		4829 <b>0049</b>
USB configuration cable		4829 <b>0050</b>
Fuse disconnect switches to protect voltage inputs (RM type)	4	5701 <b>0018</b>
Fuse disconnect switches to protect the 1-pole + neutral auxiliary power supply (RM type)	6	5701 <b>0017</b>
gG 10x38 0.5 A fuses	10	6012 <b>0000</b>