

4 Dimensions (in/mm)

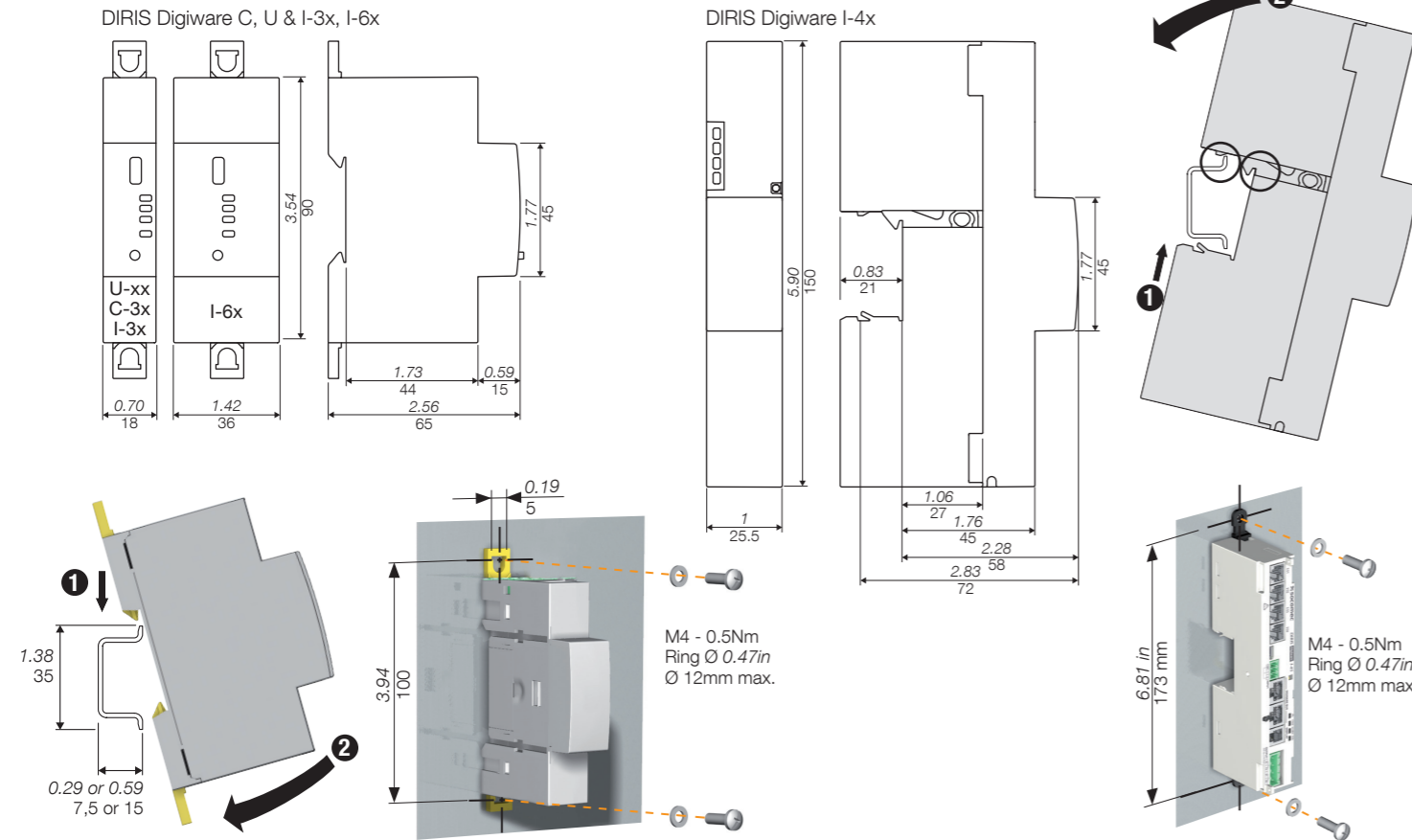

5 Current sensors

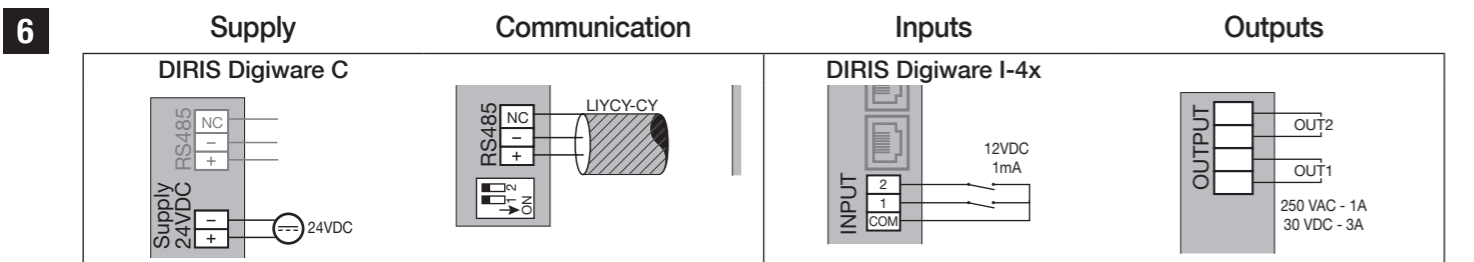
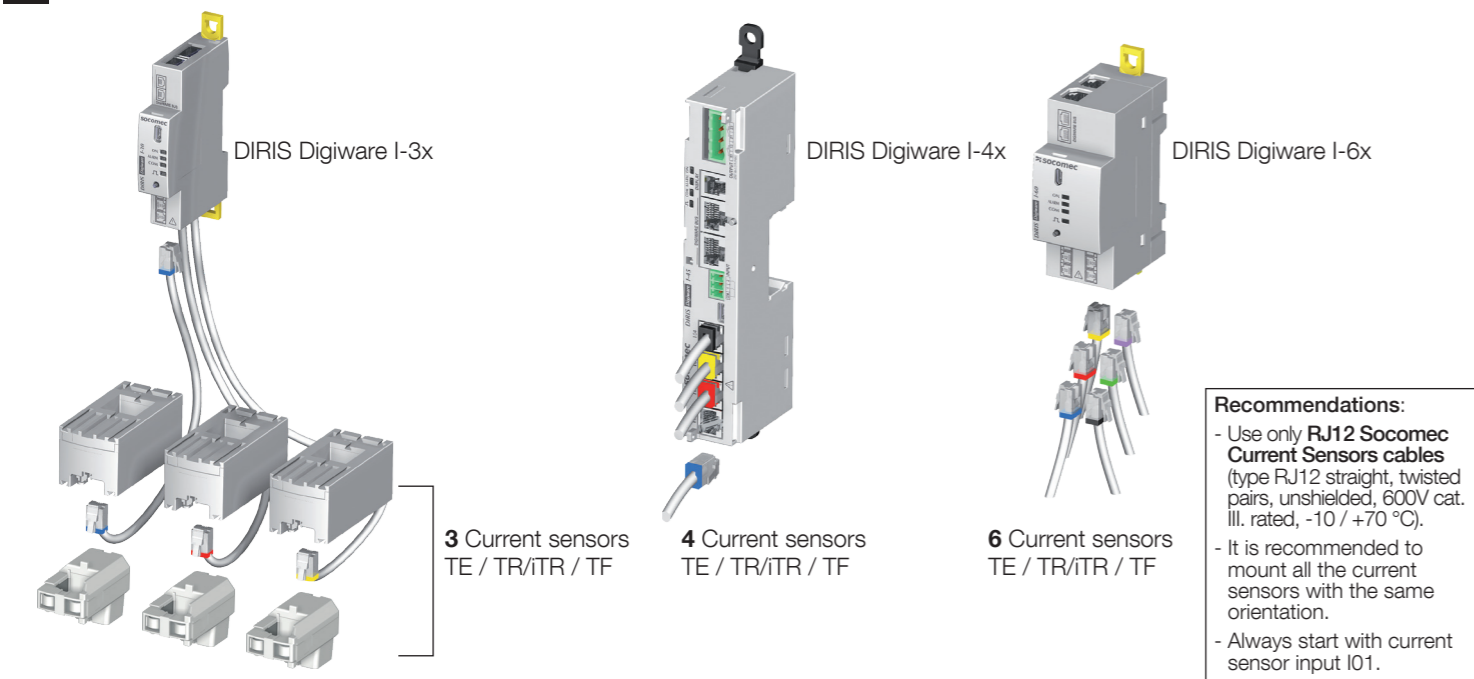

QUICK START GUIDE

EN

socomec
Innovative Power Solutions



Power Monitoring System for electrical installations

DIRIS Digiware

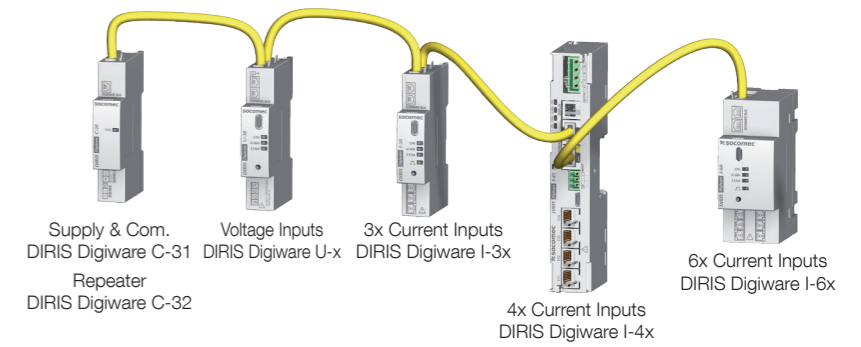

1 System wiring – exploded view

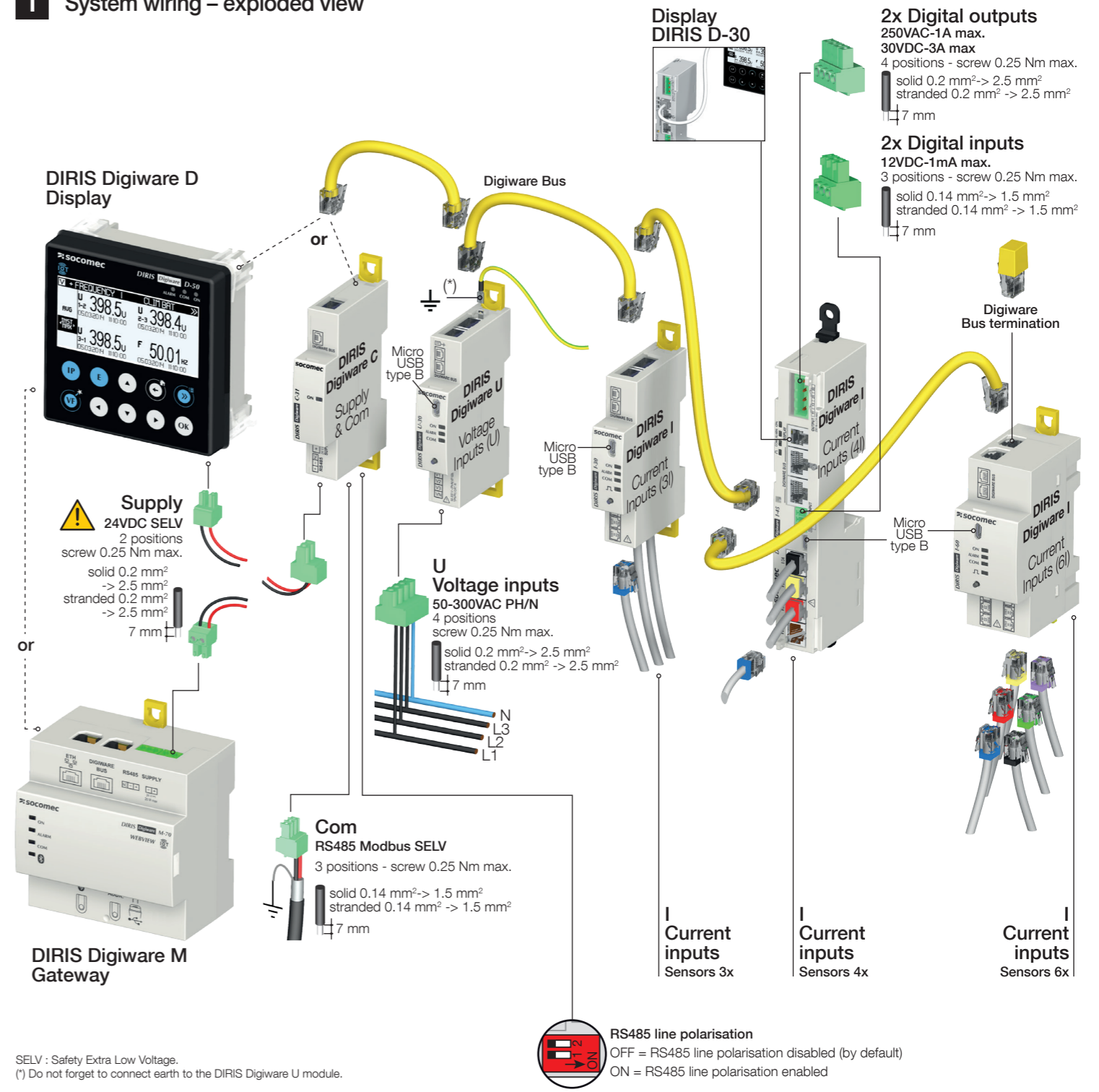

Main network connections and loads

DIRIS Digiware I-3x

Each current input setting is individual, see below some examples:



Current sensor



Balanced load

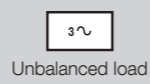

Unbalanced load

Fuse: 0.5 A gG / BS 88 2A gG / 0.5 A class CC

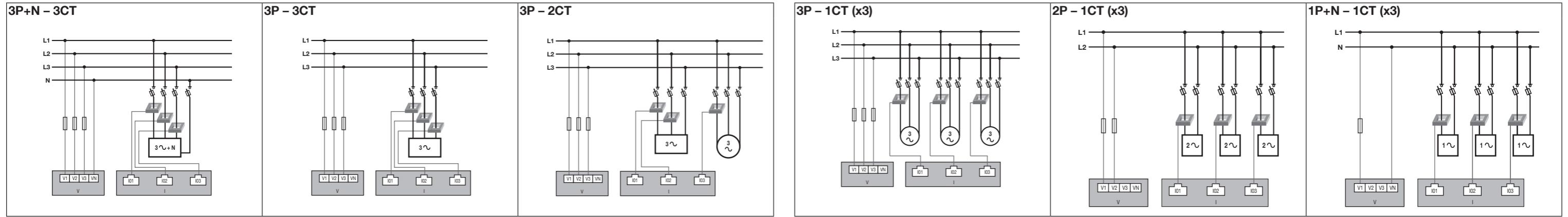

Main network connections and loads

DIRIS Digiware I-4x

Each current input setting is individual, see below some examples:



Current sensor



Balanced load

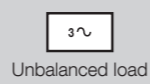

Unbalanced load

Fuse: 0.5 A gG / BS 88 2A gG / 0.5 A class CC

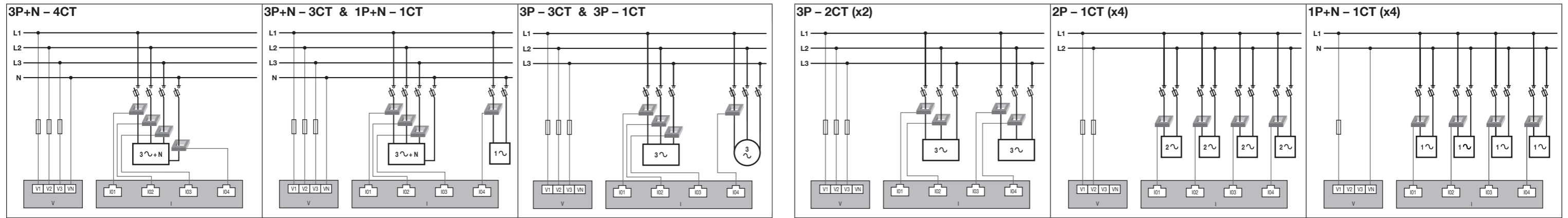

Main network connections and loads

DIRIS Digiware I-6x

Each current input setting is individual, see below some examples:

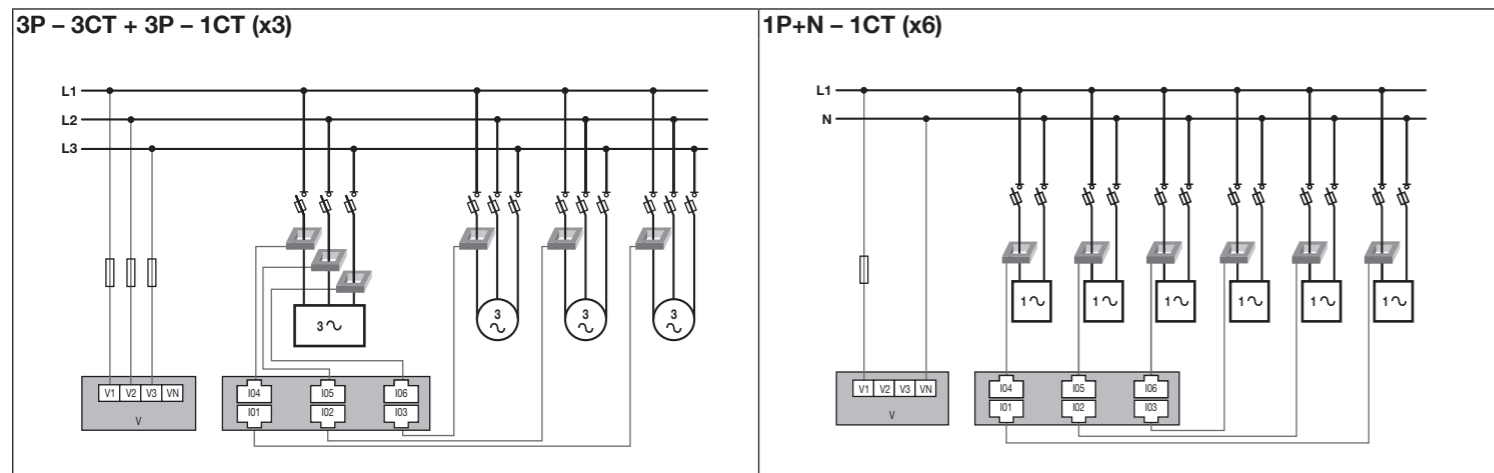

3 Configuration

Easy Config System Software

Ethernet

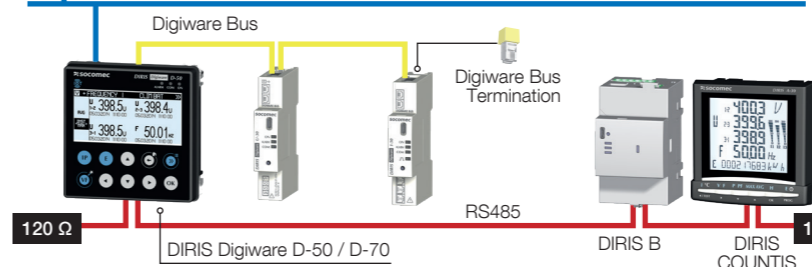

USB

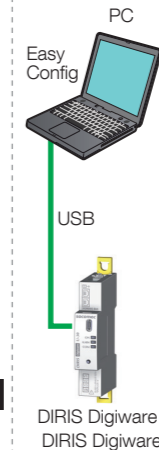

Display DIRIS Digiware D Digiware Bus

